

# Hayward/Summit Heat Pump Troubleshooting Guide



# Heat Pumps Covered by This Guide

## HeatPro

HP50TA, HP20654T, HP20654BT, HP20654TC, HP20854T, HP20854BT, HP20854TC,  
HP21104T, HP21104TC, HP21404T

**Note:** HP50TA, and HP21404T heat pumps while labeled as HeatPro,  
are built on the Summit platform.

Use Summit wiring diagrams, and error codes in your diagnostics

## Summit/ HeatMaster/ EnergyTherm/ EasyTemp

SUM25TA, SUM3TA, SUM3TAC, SUM4TA, SUM4TAC, SUM5TA, SUM5TAC  
SUM8TA, HML50TA, HML65TA, HML65TAC, HML80TA, HML80TAC, HML110TA  
HML110TAC, HML125TA, HET50BTA, HET65BTA, HET110BTA, HET125BTA  
HCB50BTA, HCB65BTA, HCB65BTAC, HCB80BTA, HCB80BTAC, HCB110BTA,  
HCB110BTAC

# Table of Contents

<b>Important Safety Information</b>	<b>1</b>	<b>HeatPro Parts Diagram</b>	<b>18</b>
<b>Basic Operation of Heat Pump</b>	<b>2</b>	<b>HeatPro Parts List</b>	<b>19</b>
<b>Normal Operation of Heat Pump</b>	<b>3-4</b>	<b>Summit/EasyTemp/HeatMaster Parts Diagram</b>	<b>20</b>
<b>Setting Heat Pumps for Remote Operation</b>	<b>5-6</b>	<b>Summit/EasyTemp/HeatMaster Parts List</b>	<b>21</b>
<b>Common Error Codes LP</b>	<b>7</b>	<b>HeatPro Wiring Diagram</b>	<b>22</b>
<b>Common Error Codes HI/HP</b>	<b>8</b>	<b>Summit/EasyTemp/HeatMaster Wiring Diagram</b>	<b>23</b>
<b>Common Error Codes PO/OP</b>	<b>9</b>	<b>Summit/EasyTemp/HeatMaster Setup Menu</b>	<b>24</b>
<b>Common Error Codes Pc/SH</b>	<b>10</b>	<b>Heat Pump Specifications</b>	<b>25</b>
<b>Common Error Codes dPO/cOP</b>	<b>11</b>	<b>Flow Charts PS/Flo</b>	<b>26</b>
<b>Common Error Codes dPc/cSH</b>	<b>12</b>	<b>Flow Charts HI/HP</b>	<b>27</b>
<b>Temperature/Resistance Charts</b>	<b>13</b>	<b>Flow Charts OP/PO- SH/Pc</b>	<b>28</b>
<b>Common Error Codes Flo/PS</b>	<b>14</b>	<b>Flow Charts cOP/dPO - cSH/dPc</b>	<b>29</b>
<b>Common Error Codes Blank Display</b>	<b>15</b>	<b>Flow Charts LP</b>	<b>30</b>
<b>Common Error Codes Fs/dEF</b>	<b>16</b>	<b>Alternative Leak Detection Methods</b>	<b>31</b>
<b>Hot Gas Bypass</b>	<b>17</b>		

# Safety

## Warning!

The following heat pump Troubleshooting Guide is to be used in diagnosing and repairing Hayward & Summit branded pool heat pump systems containing R-410A refrigerant . They are not intended for use with any other manufacturers heat pumps.

Heat Pump pool heaters are similar to the heat pumps for home heating and cooling in that they contain refrigerant. As such, service personnel should observe EPA regulations for refrigerant handling. Pool heat pumps operate on 240 volts A/C. There is a risk of electric shock at all terminals and the heat pump should only be serviced by trained personnel.

To use this guide, determine the model number of the heat pump and the nature of the problem. Refer to the Table of Contents to find the appropriate page for the problem and follow the flow charts to the solution.

If you have further questions:  
Contact Hayward's Technical Service Department at 908-355-7995



High voltage. Danger! Use extreme caution. Do not attempt if you are not a qualified servicer.

# Basic Operation of Heat Pump

Heat Pro and Summit heat pumps generally operate in the same fashion. Power is connected to the contactor per the installation instructions. Ensure the water line 'in' and 'out' connections are correct. Set the control for pool or spa operation. Adjust the thermostat setpoint above the water temperature. In approximately 3 to 5 minutes the heat pump will begin 'heating'. This 3 to 5 minute delay is important as it protects the compressor from short cycling. This time delay is part of the control circuit of the heat pump.

Hayward Heat Pro units have a 5 minute delay during which no operation will occur.

Summit brand units have a 3 minute delay, but the fan will come on immediately once the heat pump is turned on and the thermostat raised to a setpoint above the pool temp.

The time delay will delay the start of the heat pump any time power is interrupted to the heat pump. When the heat pump satisfies the thermostat and shuts off, the time delay will not allow the heat pump to restart for 3-5 minutes.

The thermostat will turn the heat pump on and off as needed to keep the pool at the desired temperature.

**Note:** Heat pumps will not operate when the pool pump is off.

# Normal Operation of Heat Pump

All of the heat pumps covered in this guide are charged with R-410A refrigerant. If you have a system that is charged with R-22 refrigerant, and require assistance call our Technical Support Department at **908-355-7995**

## Normal Refrigerant Operating Pressures

**Low side**                      **125-135psi**

Lower ambient temperatures will result in lower low side (suction) pressures.

**High Side**                      **290-400psi**

Higher water temperatures will result in higher high side (discharge) pressures.

## Normal Air Temperature Differential

This is the difference in the temperature of the air entering the coil (ambient air), and the air being discharged out the top by the fan.

**15-20 degrees Fahrenheit**

Low relative humidity and/or lower than normal ambient temperatures can cause lower than normal temperature differentials.

**Note:** This is the best way to determine if a heat pump is heating

# Normal Operation of Heat Pump

## Water In and Around Heat Pump

The heat pump evaporator coil (the surrounding coil) condenses moisture out of the surrounding air. As much as 3-5 gallons per hour of run time is common in higher humidity areas. This is normal and in fact increases the efficiency of the heat pump. The heat pump base pan design allows for a drain line to be attached using readily available components to drain this water away if it is a problem. In most installation situations however, this moisture simply runs off the pad and is absorbed into the ground.

## Best Methods to Determine if Heat Pump is Actually Leaking

1. If the heat pump is leaking, it will continue to leak even when the heat pump is not running. If the water you are seeing is condensation from the evaporator coil it will dry up in a few hours.
2. Test the water with a chlorine test strip. If the water shows no or very low levels of chlorine the water is condensation. If the test strip shows levels of chlorine similar to pool water, you may have a leak.

# Setting Heat Pumps for Remote Operation

## Heat Pro Heat Pumps

For 2 wire remotes such as Hayward's Pro-Logic, attach the 2 low voltage wires from remote to terminals 1 and 2 on terminal block TB201. Set heat pump to standby mode (three red dots scrolling across screen). Heat pump is now ready for remote operation.

## Heat Pro Heat Pumps

For 3 wire remotes where the desired temperature is set on the heat pump, attach the 3 wires from your remote to the 3, 4 and 5 terminals on terminal block TB201. Attach the pool wire to terminal 3, the common wire to terminal 4 and the spa wire to terminal 5. Set both the pool and spa desired temperature on the heat pump before turning on the remote. Once the remote is calling for pool or spa you will not be able to change the function on the heat pump without turning the remote off.

**Note:** Heat Pro HP21404T, and HP50TA are built on the Summit platform. For remote connection see next page.

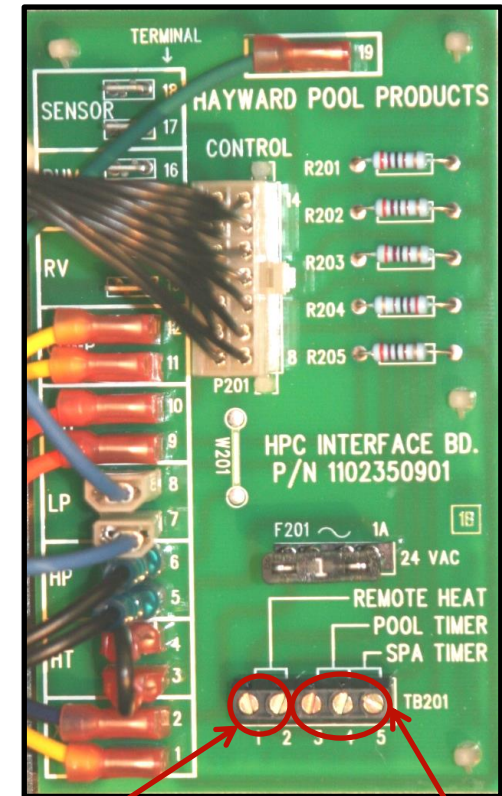

Use Terminals 1 and 2  
for 2 wire remote connection

Use Terminals 3,4,& 5  
for 3 wire remote connection



# Setting Heat Pumps for Remote Operation

## Summit Platform Heat Pumps

Attach 2 wires from remote to terminals marked 'P' and 'S' on the lower right corner of the control board.  
Set Pool temperature to off. Set Spa temperature to '104'. Press and hold 'Set/Select' button until 'Loc' appears. Release the 'Set/Select' button. Press up arrow until 50 appears. This unlocks the set up menu.  
Release up arrow. Press and release 'Set/Select' button 5 times or until 'P\_S' appears.  
Press up or down arrow until 'E' appears. Heat pump is now ready for remote operation.

**Note:** Move quickly between steps, if the temperature shows on display you will have to start over.

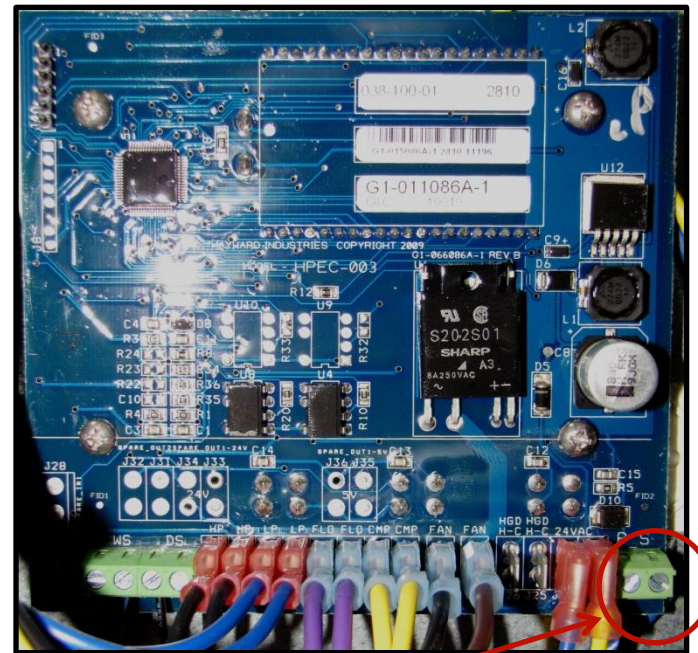
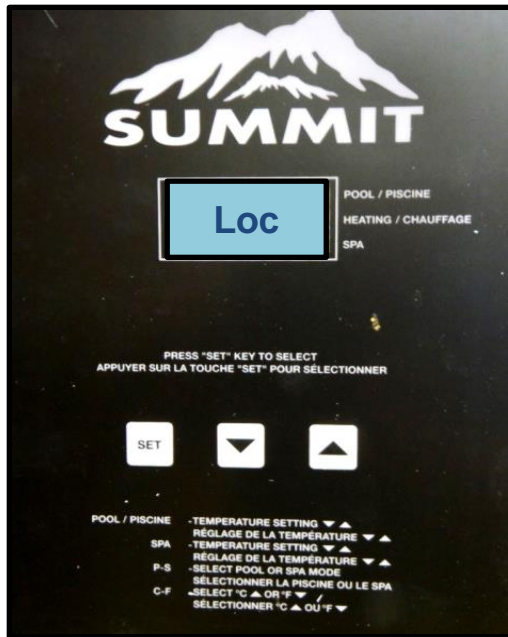

Attach 2 wires from remote to terminals P and S

# Common Error Codes

## LP on Display

LP is an indication the low pressure switch is open. The switch opens when the refrigerant pressure drops below 80PSI, and will automatically reset at 120PSI. Sustained ambient temperatures below 21°F will cause the LP error, however once the ambient temperature rises above 40°F the switch will close automatically.



HeatPro Display

## Troubleshooting LP

The most common cause of LP on display is a loss of refrigerant pressure from a leak in the refrigeration system. If refrigerant pressure is below 80PSI at your access port there has been a significant loss of charge. Thoroughly leak check the system with an electronic leak detector, or alternatively pressurize the system with dry nitrogen and use a liquid leak detector such as “Big Blue”. If a leak still cannot be located inject UV dye into the system and recharge to full charge. Allow several days to as long as several weeks -depending on apparent severity of leak-, with normal heat pump operation for the dye to leak out with the refrigerant, and return with UV light to determine leak location.

Once leak is located: Repair leak, evacuate system to a minimum 500 micron vacuum, and recharge to factory charge (on data plate)

## Other causes of LP error code

An intermittent LP code can be caused by a bad fan motor or capacitor. Check capacitor and motor.

Bad LP switch. Check refrigerant pressure at access port. If pressure is above 120PSI check the continuity of LP switch. Switch should be closed. If open replace switch. The LP switch is a screw on style and does not require removing refrigerant charge to change. Be sure to use a thread sealant when installing new switch. Always use a back up wrench when installing new pressure switch.

**If switch is closed**, but LP is displayed check wires to switch for breaks. If no breaks are found replace control board.

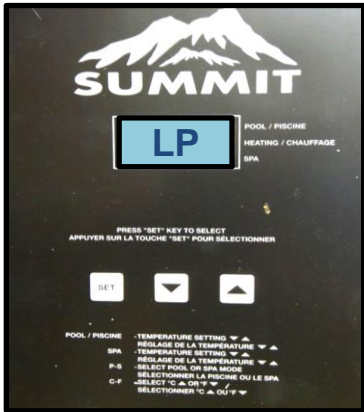

Summit Display



LP Switch

Note blue wires.

LP switch common to all R-410A heat pumps

# Common Error Codes

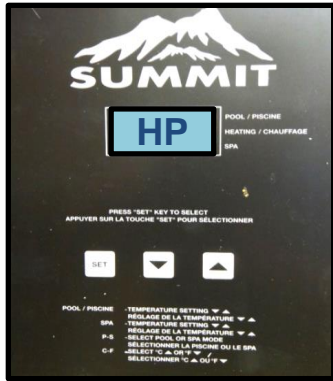

Summit Display



## HP Switch

Note black wires.  
HP switch common to all  
R-410A heat pumps

## HP/HI on Display

HP or HI is an indication the high pressure switch is open. The switch opens when the refrigerant pressure rises above 590PSI, and will automatically reset at 440PSI..



HeatPro Display

## Troubleshooting HP/HI

The most common cause of HP or HI error code is restricted water flow. An open bypass valve that allows the heat exchanger to be pressurized, but does not allow flow through it is a likely culprit. When heating a spa, there may not be sufficient flow through the system for proper operation at higher water temperatures. All heat pumps require a minimum of 30 gpm water flow, but at higher water temperatures a higher flow rate of at least 40 gpm may be required.

## Other causes of HP/HI error code

### Heat Pump runs for a few seconds then fails on HP/HI error

Thermostatic Expansion Valve (TXV) failure. Loss of charge in the power head of the TXV closes the valve and will result in a HP or HI error code. To determine if this is the problem, observe both high and low pressure readings when heat pump is running. If TXV is bad high pressure will quickly rise to 590PSI, while at the same time the low pressure will quickly drop.

Refrigerant Overcharge Overcharge of the heat pump is unlikely, but not impossible. Heat pumps do not leave our factory overcharged, so the only way it can occur is if service has been previously performed on the system and the technician overcharged the refrigerant after or during a repair. To determine if this is the issue recover all refrigerant from the system, pull a 500 micron vacuum, and then recharge to factory charge (on data plate).

## Heat Pump does not run- HP/HI on display

Bad HP switch. Since the HP switch is an automatic reset, and the pressures within the refrigeration system will equalize shortly after the heat pump cuts off, HP or HI on the display without the heat pump running will not be related to the refrigerant pressure check the continuity of HP switch. Switch should be closed. If open replace switch. The HP switch is a screw on style and does not require removing refrigerant charge to change. Be sure to use a thread sealant when installing new switch. Always use a back up wrench when installing new pressure switch.

If switch is closed, but HP/HI is displayed check wires to switch for breaks.

If no breaks are found replace control board.

# Common Error Codes

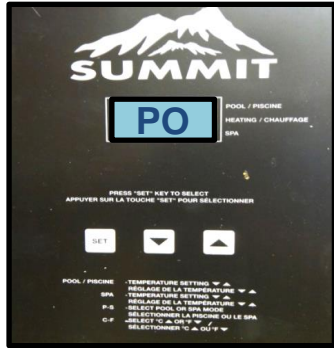

Summit Display

## PO/OP on Display

PO or OP is an indication of an open water temperature sensor.

Summit style heat pumps use a 4.8k ohm sensor, and HeatPro heat pumps use a 10k ohm sensor.



HeatPro Display

## Troubleshooting PO/OP

The most common cause of PO or OP error code is an open water temperature sensor. Check sensor wiring for breaks, and check sensor resistance against the correct temperature/resistance chart located on page 11.

If resistance is infinite or very high according to the chart replace the sensor.

If sensor reads the correct resistance for the temperature of the water, replace control board

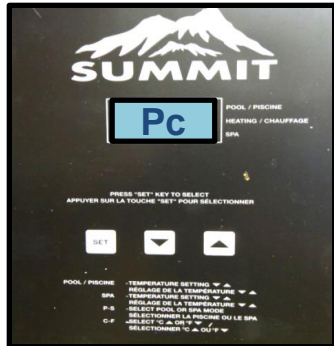

Summit Display

## Pc/SH on Display

Pc or SH is an indication of an shorted water temperature sensor.

Summit style heat pumps use a 4.8k ohm sensor, and HeatPro heat pumps use a 10k ohm sensor.



HeatPro Display

## Troubleshooting Pc/SH

The most common cause of Pc or SH error code is a shorted water temperature sensor. Check sensor wiring for shorted wires, and check sensor resistance against the correct temperature/resistance chart located on page 11.

If resistance is 0 or very low according to the chart, replace the sensor.

If sensor reads the correct resistance for the temperature of the water, replace control board

# Common Error Codes

## dPO/cOP on Display

dPO or cOP is an indication of an open defrost temperature sensor.

Summit style heat pumps use a 4.8k ohm sensor, and HeatPro heat pumps use a 10k ohm sensor..



HeatPro Display

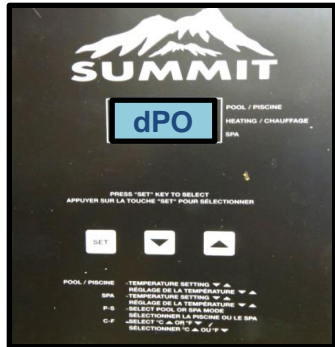

Summit Display

## Troubleshooting dPO/cOP

The most common cause of dPO or cOP error code is an open defrost temperature sensor. Check sensor wiring for breaks, and check sensor resistance against the correct temperature/resistance chart located on page 11.

If resistance is infinite or very high according to the chart replace the sensor.

If sensor reads the correct resistance for the temperature of the water, replace control board

## dPc/cSH on Display

Pc or SH is an indication of an shorted water temperature sensor.

Summit style heat pumps use a 4.8k ohm sensor, and HeatPro heat pumps use a 10k ohm sensor.



HeatPro Display

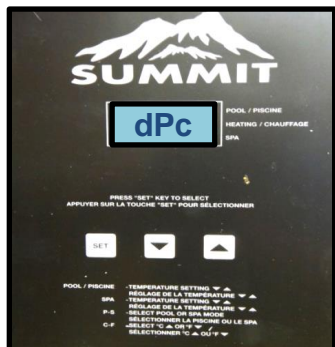

Summit Display

## Troubleshooting dPc/cSH

The most common cause of Pc or SH error code is a shorted defrost temperature sensor. Check sensor wiring for shorted wires, and check sensor resistance against the correct temperature/resistance chart located on the page11.

If resistance is 0 or very low according to the chart, replace the sensor.

If sensor reads the correct resistance for the temperature of the water, replace control board

# Temperature/Resistance Charts

## For use with Summit Heat Pumps

4.8 K ohm Sensor Temperature / Resistance Chart

Temperature °F	Temperature °C	Sensor resistance (Kohm)
180.0	82.2	0.549
175.0	79.4	0.601
170.0	76.7	0.659
165.0	73.9	0.722
160.0	71.2	0.793
155.0	68.4	0.872
150.0	65.7	0.961
145.0	62.9	1.06
140.0	60.2	1.17
135.0	57.4	1.294
130.0	54.7	1.434
125.0	51.9	1.591
120.0	49.2	1.768
115.0	46.4	1.968
110.0	43.7	2.194
105.0	40.9	2.451
100.0	38.2	2.741
95.0	35.4	3.072
90.0	32.7	3.448
85.0	29.9	3.879
80.0	27.2	4.37
75.0	24.4	4.935
70.0	21.7	5.583
65.0	18.9	6.328
60.0	16.2	7.187
55.0	13.4	8.18
50.0	10.7	9.334
45.0	7.9	10.671
40.0	5.2	12.23
35.0	2.4	14.044
30.0	-0.3	16.167
25.0	-3.1	18.655
20.0	-5.8	21.581
15.0	-8.6	25.036
10.0	-11.3	29.11
5.0	-14.1	33.95
0.0	-16.8	39.683

### Summit Sensors



Defrost



Water

**Using Temp/Resistance Charts**  
 Determine correct temperature of air or water using accurate thermometer. Set VOM meter to a minimum of 20K ohms. Read resistance of sensor.(wire to wire) Resistance should match the temperature shown on the chart.



**In the example above:**  
 The meter on the left shows a temperature of 73.6°F  
 The meter on the right shows a resistance through the sensor of 10.84K ohms.  
 Checking the chart on the right for 73.6 degrees shows the resistance should be somewhere between 11.882 (70°) and 10.50 (75°)  
 Sensor tests good.

## For use with HeatPro Heat Pumps

10K ohm Sensor Temperature / Resistance Chart

Temperature °F	Temperature °C	Sensor resistance (Kohm)
180.0	82.2	1.171
175.0	79.4	1.281
170.0	76.7	1.402
165.0	73.9	1.538
160.0	71.2	1.688
155.0	68.4	1.856
150.0	65.7	2.044
145.0	62.9	2.254
140.0	60.2	2.489
135.0	57.4	2.752
130.0	54.7	3.049
125.0	51.9	3.382
120.0	49.2	3.758
115.0	46.4	4.183
110.0	43.7	4.664
105.0	40.9	5.208
100.0	38.2	5.827
95.0	35.4	6.53
90.0	32.7	7.333
85.0	29.9	8.249
80.0	27.2	9.297
75.0	24.4	10.5
70.0	21.7	11.882
65.0	18.9	13.473
60.0	16.2	15.31
55.0	13.4	17.435
50.0	10.7	19.9
45.0	7.9	22.764
40.0	5.2	26.1
35.0	2.4	29.998
30.0	-0.3	34.561
25.0	-3.1	39.919
20.0	-5.8	46.225
15.0	-8.6	53.669
10.0	-11.3	62.479
5.0	-14.1	72.937
0.0	-16.8	85.387

### HeatPro Sensors

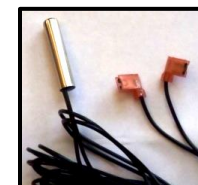

Defrost



Water

# Common Error Codes

## Flo/PS on Display

Flo or PS on the display is an indication of an open water pressure switch. Though water pressure switches occasionally fail, the majority of Flo/PS errors are water flow related. Confirm that pump is running and filter is clean before proceeding with any further troubleshooting. The water pressure switch is located in the electrical panel.



HeatPro Display

## Troubleshooting Flo/PS

The most common cause of HP or HI error code is low or no water flow. Open bypass valves, time clocks in the off cycle, pumps turned off, and dirty filter account for the majority of Flo and PS errors. If water flow is confirmed check continuity of the flow switch with an Volt/Ohm meter. **See Below** Disconnect wires from water pressure switch and **with the pool pump running and any bypasses closed** check for continuity through the switch, not through the wires. If there is no continuity, try adjusting the switch slightly by turning the thumbscrew counterclockwise 1 full turn. If there is still no continuity, replace switch.

If switch is closed, but Flo/PS is displayed check wires to switch for breaks. If no breaks are found replace control board.

**Note:** Any time water pressure switch is adjusted- After adjusting switch cut off pool pump to ensure heat pump cuts off on no water flow.

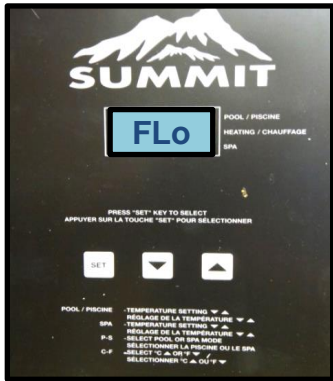

Summit Display

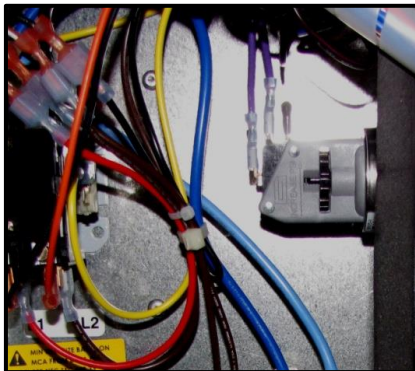

Summit Water Pressure Switch

## To test continuity of flow switch:

Remove orange wires from switch for HeatPro  
Remove purple wires from switch for Summit  
Set VOM to Ohms, and check for continuity at switch- not wires.

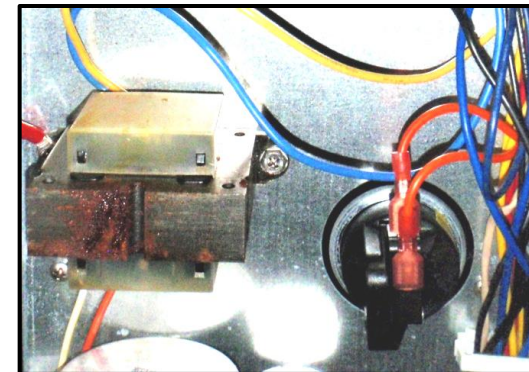

HeatPro Water Pressure Switch

# Common Error Codes

## Blank Display

A blank display is an indication of no low voltage to control.  
A tripped breaker is a likely cause.  
On HeatPro models a blown 1 amp fuse will result in a blank display



HeatPro Display

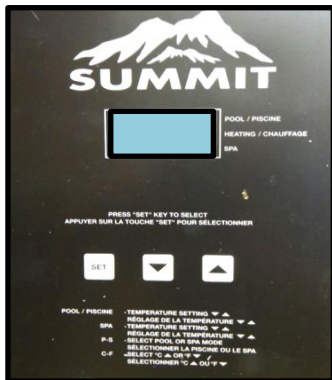

Summit Display

## Troubleshooting a Blank Display

Check for 240 volts to contactor at L1 and L2 terminals. If there is 240 volts at L1 and L2 check for 24 volts between blue and yellow wires coming from transformer.

**On Summit units** if 24 volts are present at blue and yellow wires replace control board.

**On HeatPro units** if 24 volts are present check for blown fuse on interface board. If fuse is good replace control board

**Common causes** of blown fuse or bad transformer are pinched or shorted low voltage wires to low and high pressure switches. Check all wiring for short or ground  
Contactor coil shorted or grounded. Contactors should have approx. 10 Ohms resistance through coil, and there should be no reading of continuity to ground.  
Replace contactor if resistance exceeds 12 Ohms, or there is any continuity to ground.

## HeatPro

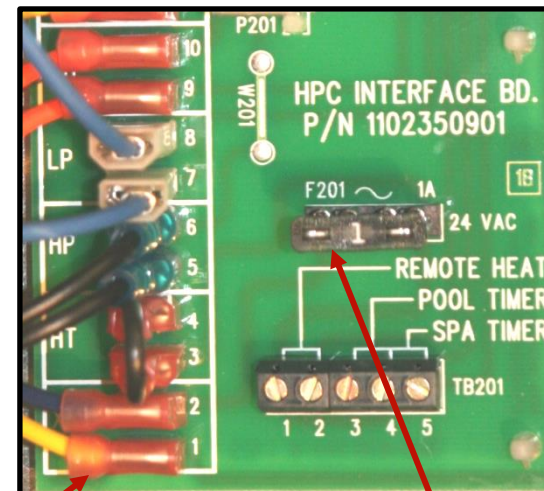

1 Amp fuse to protect low voltage circuit HeatPro only

## Summit

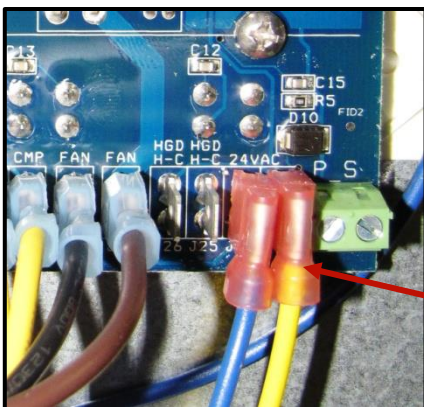

Check for 24 volts AC at blue and yellow wires



# Common Error Codes

## FS/deF on Display

FS or deF on the display is an indication that the heat pump is in the defrost mode. If outdoor ambient temperatures are low to mid 50's or below this is normal operation

## Troubleshooting FS/deF

Normal display when heat pump is in defrost mode. Defrost can occur any time the outdoor ambient temperatures fall into the mid 50's or below.

### If you have FS/ deF when temps are above mid 50's

This could be an indication the defrost temperature sensor is failing. Check sensor against resistance charts on page 11. If sensor resistance does not match with correct reading from chart replace sensor. If resistance is correct replace control board

## Defrost Sequence

### Heat Pro

When defrost sensor senses a coil temperature of 29°F, the control board cuts the compressor off but leaves the fan running for 15 minutes, the display will show only the water temperature during this time. If temperature of sensor is 50°F or above after 15 minutes the will compressor restart and the heat pump is operating normally. If the temperature has not reached 50°F the heat pump will go through up to 2 more 15 minute cycles. If after the 3<sup>rd</sup> cycle the temperature is still not above 50°F the heat pump will shut down for 2 hours and show deF on the display.

### Summit

When defrost sensor senses a coil temperature of 29°F, the control cuts the compressor off and leaves the fan running. The display shows FS. The heat pump will continue to operate in this way until the sensor senses 42°F. Once the sensor reaches 42°F the compressor will restart and the heat pump is operating normally.

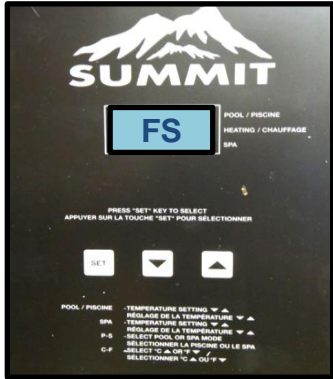

Summit Display

### Summit

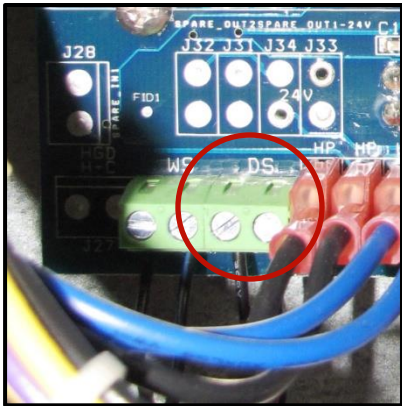

Defrost Sensor Wire Location



HeatPro Display

**Note:** Defrost sensors are attached to suction refrigerant line with the TXV bulb.

### HeatPro

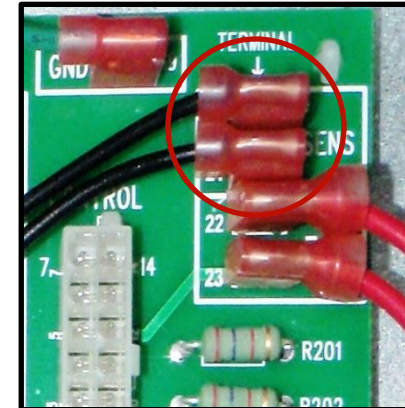

Defrost Sensor Wire Location

# Hot Gas Bypass (HGBP)

designated by a C at end of model number

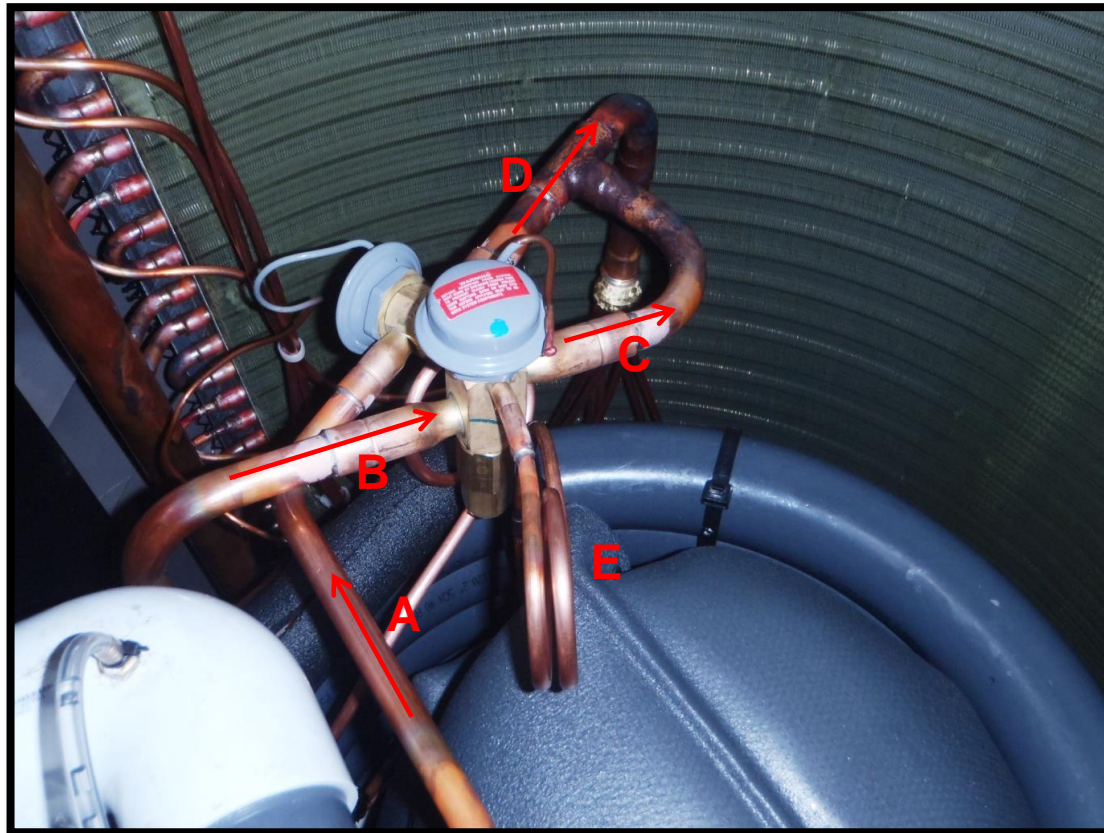

- A. Liquid line to TXV
- B. Hot gas line to HGBP is tee'd into the hot gas line going to the condenser.
- C. Hot gas line from HGBP is tee'd into liquid line downstream of TXV
- D. Liquid line downstream of TXV
- E. Low pressure tube attached to suction line entering compressor

## **Sequence of Operation**

The diaphragm in the HGBP regulates the suction pressure by opening and closing the valve and allowing some of the hot gas that would normally go into the condenser to flow into the liquid line downstream of the TXV.

As the suction pressure drops below 98 psi, (~31° F) loss of pressure from the suction line on the diaphragm (E) will result in the HGBP valve opening to allow hot gas to enter the liquid line downstream of the TXV. This will keep the suction pressure up and the evaporator temperature above the defrost point, allowing the heat pump to operate in cooler temperatures.

## **Trouble Shooting:**

Symptoms of a failed hot gas bypass

1. Stuck open- abnormally high superheat (more than 15° F), loss of heating capacity
2. Stuck closed- heat pump defrosts more than normal, will not run at lower temperatures (below 50° F)

# HeatPro Exploded View

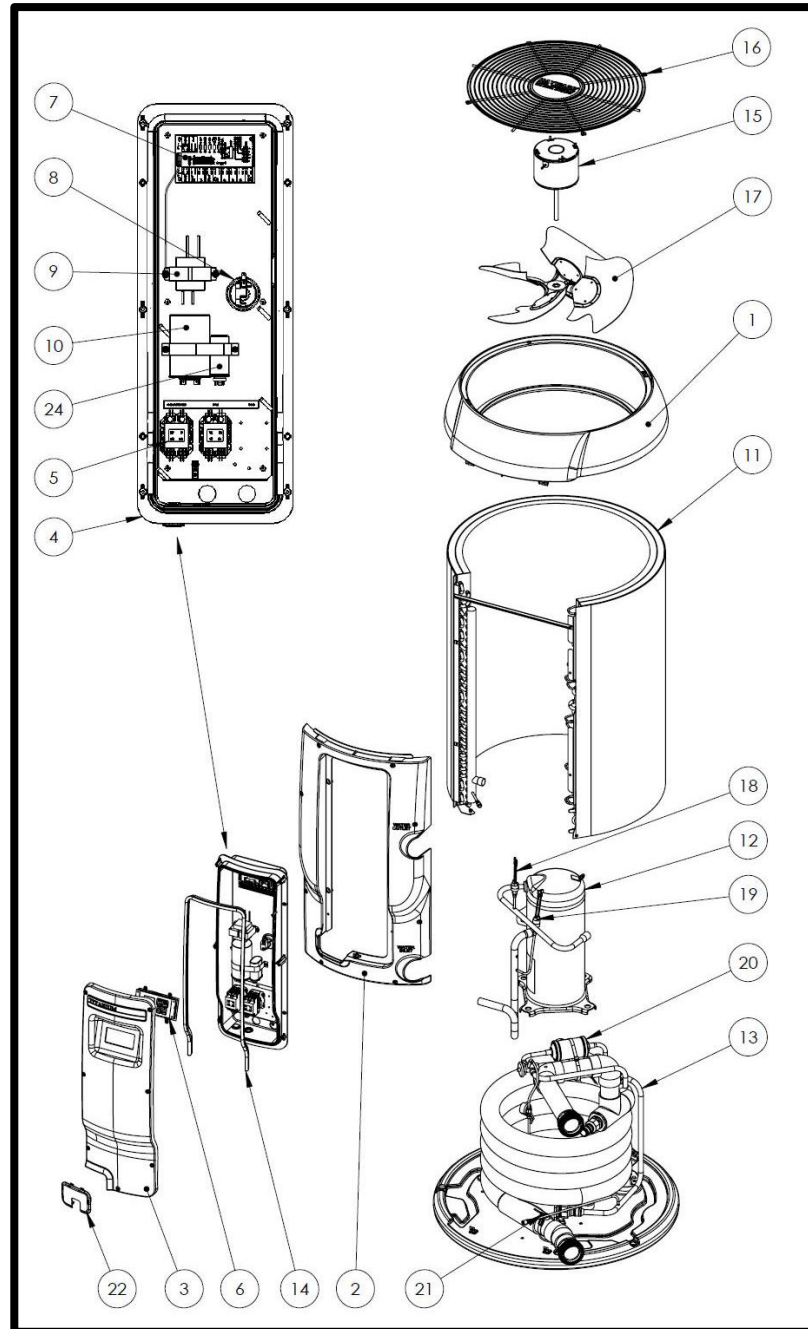

**Note:**

HP50TA built on Summit platform.  
Use SUM25TA parts list  
HP21404T built on Summit platform.  
Use SUM8TA parts list

# HAYWARD HEAT PRO 4T PARTS LIST

	Part description	HP21104T	HP20854T	HP20854BT (Canada only)	HP20654T	HP20654BT (Canada only)	
1	FAN TOP	HPX01023502		HPX01024821	HPX01023502	HPX01024821	
2	SIDE PANEL	HPX01023503		HPX01024822	HPX01023503	HPX01024822	
3	CONTROL BOX COVER	HPX01023504					
4	CONTROL BOX	HPX01023505					
5	CONTACTOR	HPX1985					
6	CONTROL BOARD ASSY	HPX26024139					
7	INTERFACE BOARD	HPX11024130					
8	WATER PRESSURE SWITCH	HPX2181					
9	TRANSFORMER	HPX11023693					
10	CAPACITOR	HPX11024743	HPX11024272		HPX11024270		
11	BENT COIL with GUARD	HPX24024241	HPX24024238				
12	COMPRESSOR	HPX11024203	HPX11024204		HPX11024257		
13	CONDENSER	HPX24024210	HPX24024712				
14	COVER GASKET	HPX05023549					
15	FAN MOTOR, 1/3 HP	HPX11023564					
16	FAN GUARD	HPX01023561					
17	FAN BLADE	HPX15024321					
18	REPLACEMENT HP SWITCH	HPX11024258					
19	REPLACEMENT LP SWITCH	HPX11024259					
20	EXPANSION VALVE ASSY	HPX15024214	HPX15024215		HPX15024216		
21	TEMPERATURE SENSOR	HPX2169					
22	ELECTRICAL ENTRY PLUG	HPX01023760					
23	FAN RUN CAPACITOR	HPX11024151					
24	DEFROST SENSOR (NS)	HPX11024169					
25	HPC CABLE (NS)	HPX10023517					
26	COMPRESSOR MOUNT KIT (NS)	HPX0054					
27	COMPRESSOR EL. PLUG (NS)	HPX10024289			HPX10024732		
28	REPLACEMENT FILTER DRIER	HPX1462					
29	UNION KIT	SPX3200UNKIT					
30	HOT GAS BYPASS VALVE (NS) MODELS ONLY	SMX15026191	HPX15026180				
31	COREMAX ACCESS FITTING (NS)	HPX15026200					
32	BRASS WATER PRESSURE FITTING	HPX2215					

# SUMMIT TITANIUM MODELS

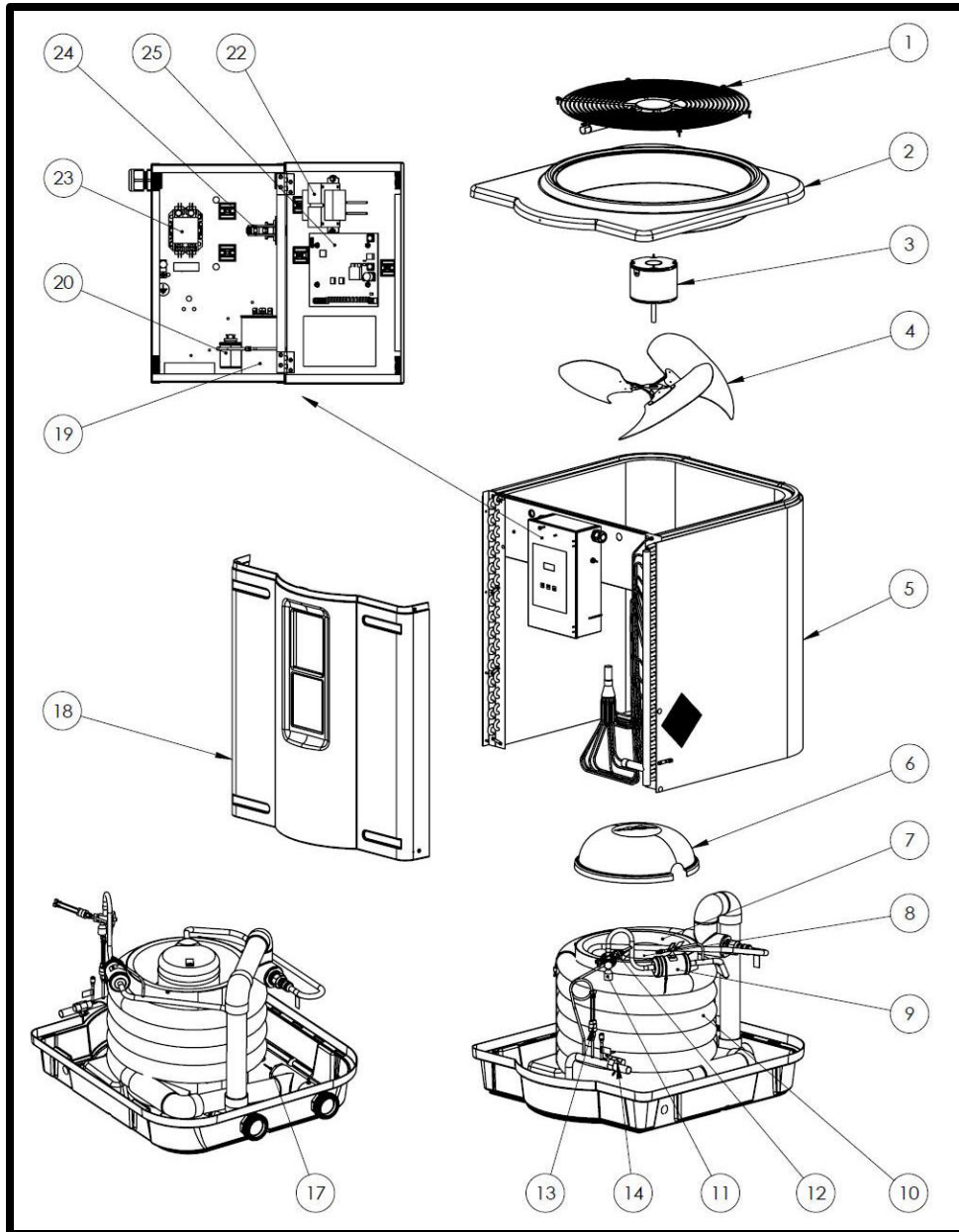

	Part Description	Summit By Hayward					
		SUM25TA (Canada only)	SUM3TA	SUM4TA	SUM5TA		SUM8TA
1	FAN GUARD	SMX305000004					
2	FAN TOP	SMX309077011					
3	FAN MOTOR	SMX303088001			SMX300055036		
4	FAN BLADE	SMX15024648	SMX303140002		SMX303140003		
5	BENT COIL with GUARD	SMX24024427	SMX24024414		SMX24024408	SMX305099004	
6	ACCUSTICAP	SMX01024512					
8	COMPRESSOR	SMX11024624	SMX11024622	SMX11024621	SMX301150010	SMX11024201	
9	FILTER DRIER	HPX1462					
10	CONDENSER	SMX24024500	SMX24024804		SMX24024509	SMX24024864	
11	TXV ASSEMBLY	SMX15024592	SMX15024593	SMX15024594	SMX15024595	SMX15024907	
12	HP SWITCH	HPX11024258					
13	LP SWITCH	HPX11024259					
14	DEFROST (COIL) SENSOR	SMX306000023					
17	WATER SENSOR	SMX306000024					
18	SIDE PANEL	SMX309077013	SMX309099013				SMX309099015
19	COMPRESSOR CAPACITOR	SMX306150002	HPX11024154	HPX11024272	HPX11024743		
20	FAN RUN CAPACITOR	SMX306088001			HPX11024151		
22	TRANSFORMER	HPX11023693					
23	CONTACTOR	HPX1985					
24	WATER PRESSURE SWITCH	HPX2181					
25	CONTROL BOARD ASSEMBLY	SMX306000016					
	COUPLING (NS)	SPX3200UNKIT					
	COMPRESSOR ELECT. PLUG(NS)	SMX10024283	SMX306066002				
	HOT GAS BYPASS VALVE (NS)	SMX15026191					
	COREMAX ACCESS FITTING (NS)	HPX15026200					
	BRASS WATER PRESSURE FITTING (NS)	HPX2215					

	Part Description	HeatMaster/Energy Therm/Easy Temp				
		50TA (Canada only)	65TA	80TA	110TA	125TA
1	FAN GUARD	SMX305000004				
2	FAN TOP	SMX309077021				
3	FAN MOTOR	SMX303088001			SMX300055036	
4	FAN BLADE	SMX15024648	SMX303140002		SMX303140003	
5	BENT COIL with GUARD	SMX24024427	SMX24024414		SMX24024408	
6	ACCUSTICAP	SMX01024512				
8	COMPRESSOR	SMX11024624	SMX11024622	SMX11024621	SMX301150010	SMX11024201
9	FILTER DRIER	HPX1462				
10	CONDENSER	SMX24024500	SMX24024804		SMX24024509	SMX24024510
11	TXV ASSEMBLY	SMX15024592	SMX15024593	SMX15024594	SMX15024595	SMX15024907
12	HP SWITCH	HPX11024258				
13	LP SWITCH	HPX11024259				
14	DEFROST (COIL) SENSOR	SMX306000023				
17	WATER SENSOR	SMX306000024				
18	SIDE PANEL	SMX309077023	SMX309099023			
19	COMPRESSOR CAPACITOR	SMX306150002	HPX11024154	HPX11024272	HPX11024743	
20	FAN RUN CAPACITOR	SMX306088001			HPX11024151	
22	TRANSFORMER	HPX11023693				
23	CONTACTOR	HPX1985				
24	WATER PRESSURE SWITCH	HPX2181				
25	CONTROL BOARD ASSEMBLY	SMX306000016				
	COUPLING	SPX3200UNKIT				
	COMPRESSOR ELECT. PLUG(NS)	SMX10024283	SMX306000042			
	COREMAX ACCESS FITTING (NS)	HPX15026200				
	BRASS WATERPRESSURE FITTING (NS)	HPX2215				

# HeatPro Wiring Diagram

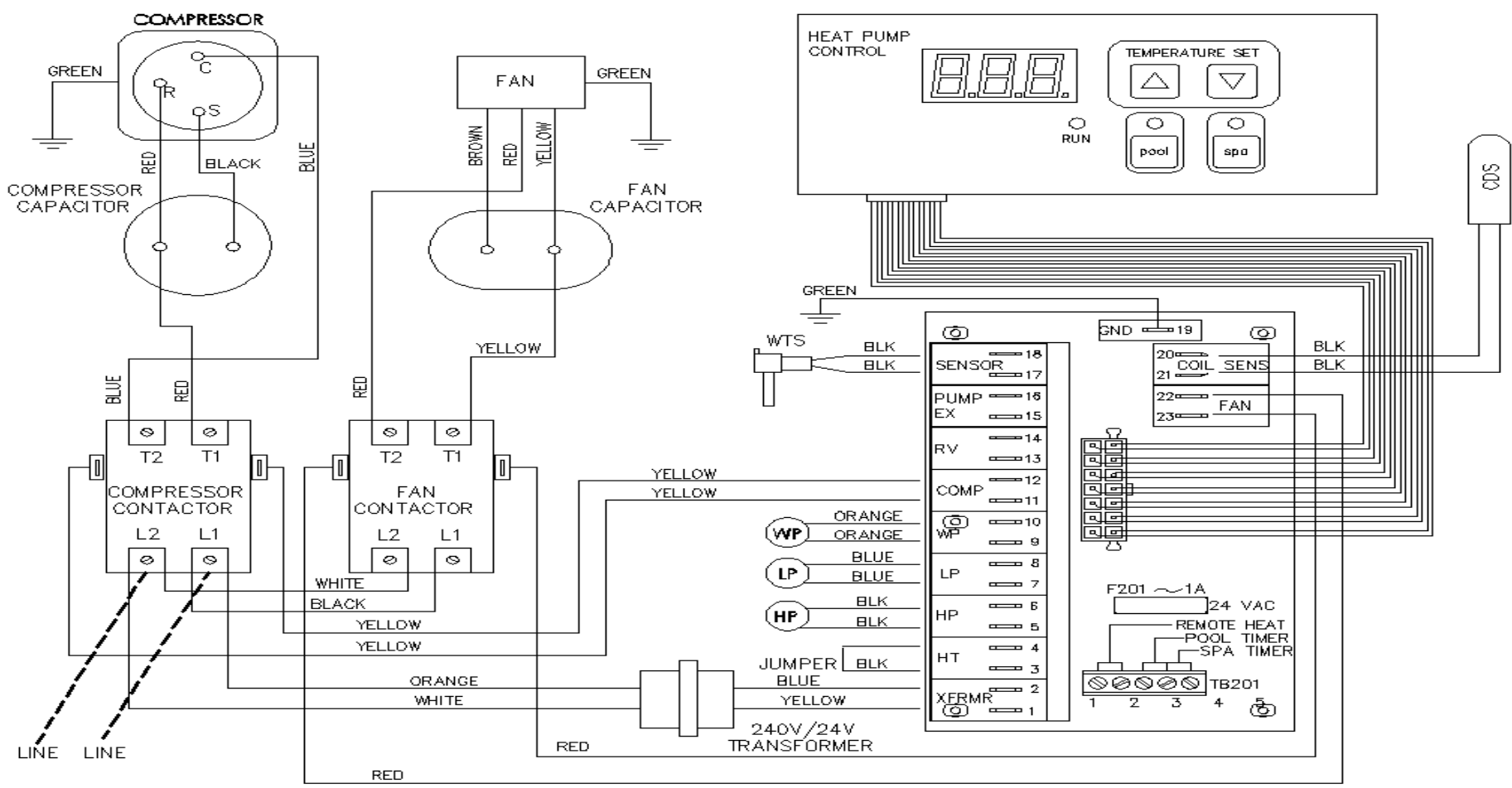

FAN - FAN MOTOR  
 SENSOR (WTS) - WATER TEMPERATURE SENSOR  
 PUMP EX - NOT USED  
 RV - NOT USED  
 COMP - COMPRESSOR CONTACTOR  
 WP - WATER PRESSURE SWITCH (N/O)

LP - LOW PRESSURE SWITCH (N/C)  
 HP - HIGH PRESSURE SWITCH (N/C)  
 HT - HIGH TEMPERATURE SWITCH (N/C)  
 XFRMR - TRANSFORMER  
 GND - GROUND TERMINALS  
 COIL SENS (CDS) - COIL DEFROST SENSOR

**⚠ WARNING**  
 THIS MODEL IS DESIGNED FOR  
 MULTIPLE POWER SUPPLIES.  
 CHECK ALL INPUT LINES  
 BEFORE SERVICING.

HP13024143

**Note:** HP21404T, and HP50TA are built on the Summit Platform. Use Summit wiring diagram for reference.

# Summit/HeatMaster/EnergyTherm/EasyTemp Wiring Diagram

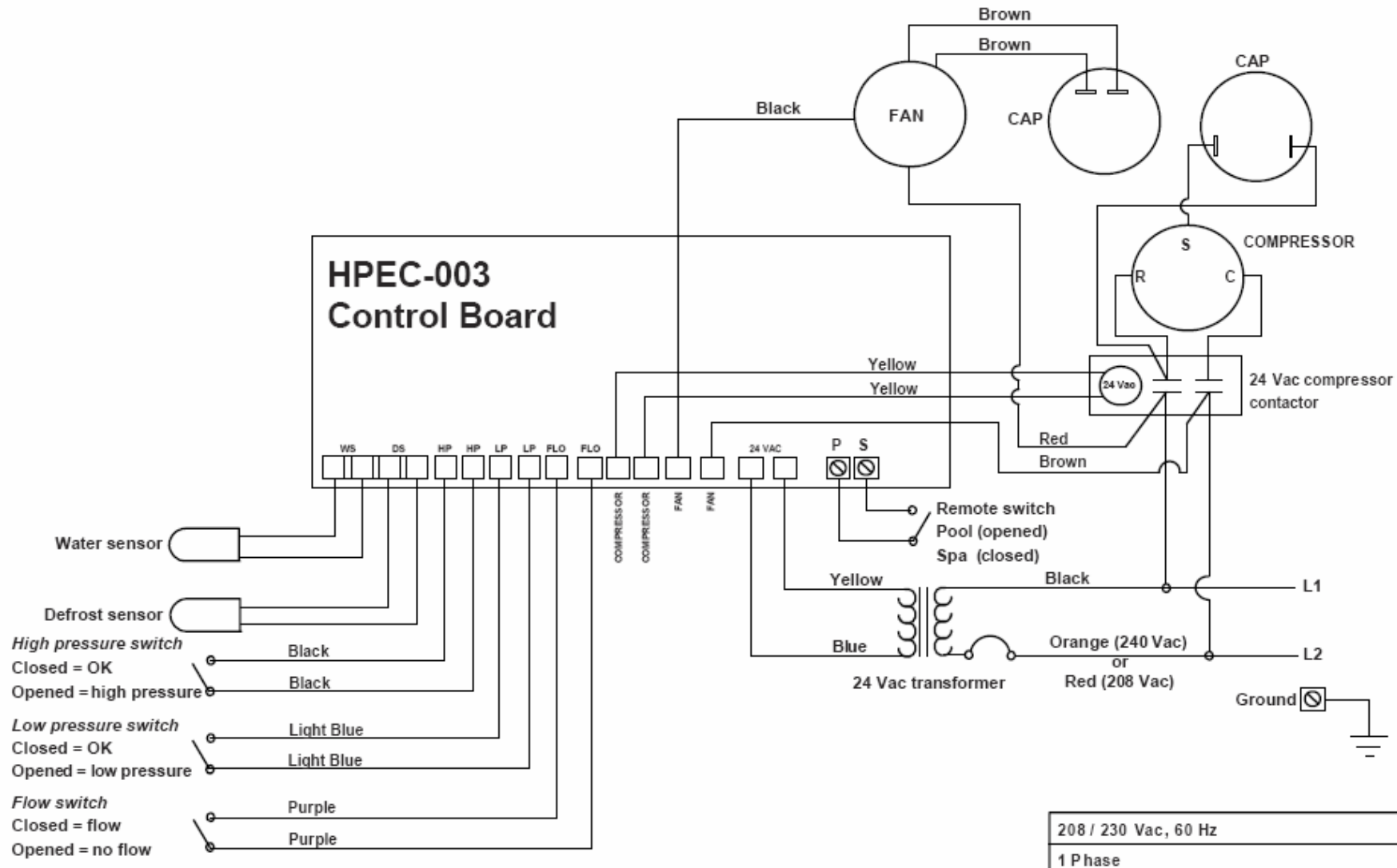



# Summit/EnergyTherm/HeatMaster/EasyTemp Setup Menu

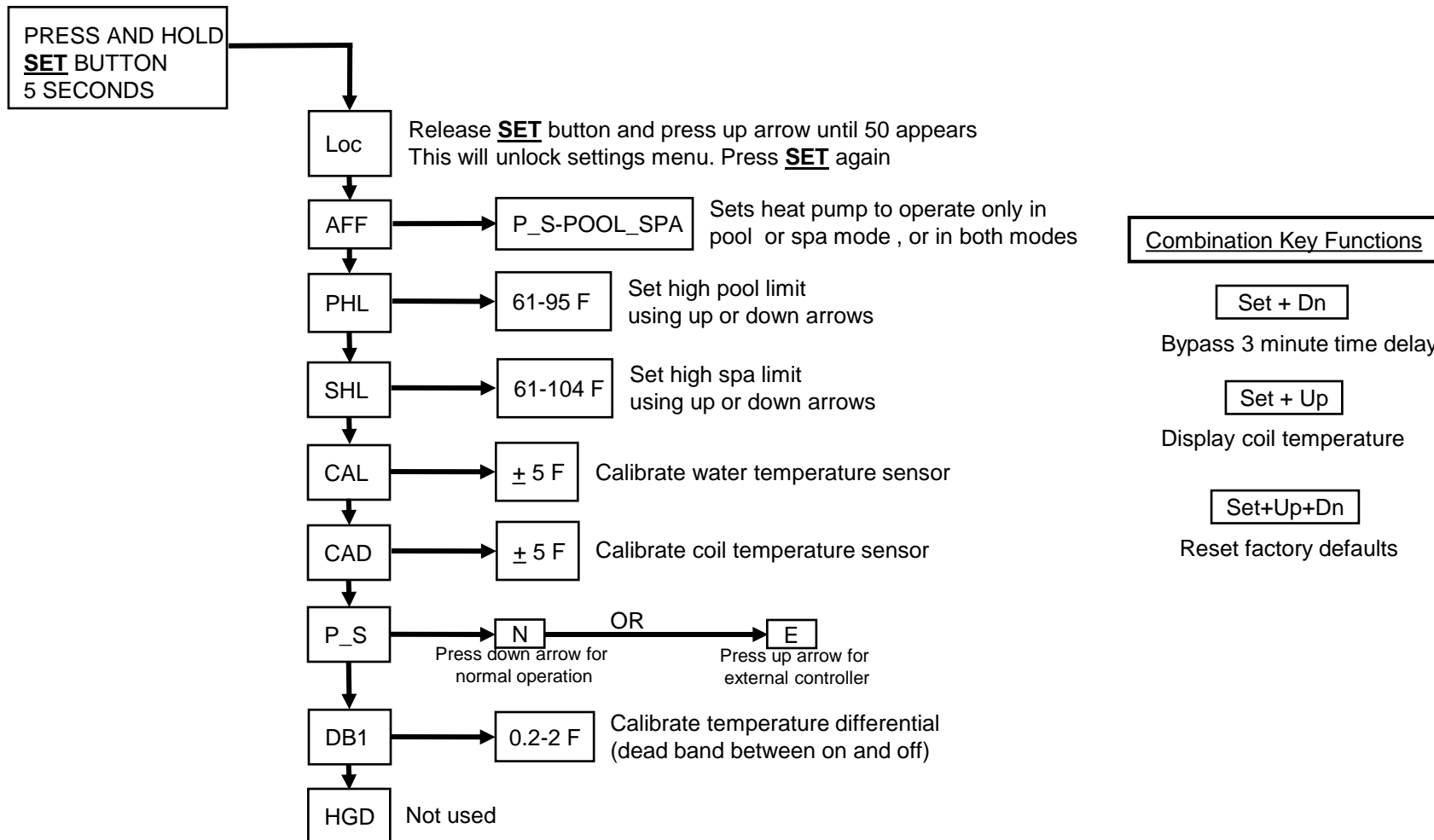

# Heat Pump Specifications

Description	HeatPro Specifications				
	HP50TA*	HP20654T	HP20854T	HP21104T	HP21404T*
Model number	HP50TA*	HP20654T	HP20854T	HP21104T	HP21404T*
Refrigerant Type	R-410A	R-410A	R-410A	R-410A	R-410A
Factory Charge	3 lbs. 0 oz.	3 lbs. 14 oz.	4 lbs. 2 oz	5 lbs. 6 oz.	5 LBS. 13.5 OZ.
Factory Test Pressure	440 psig	441 psig	441 psig	441 psig	441 psig
Compressor Amps	10.5	17.9	28	27	27
Compressor LRA	60	112	135	145	145
Fan Amps	1.3	1.8	1.8	1.8	2.4
Fan LRA	2.8	2.8	2.8	2.8	4.3
Minimum Water Flow	30	30	30	30	30
Maximum Water Flow	75	75	75	75	75
Maximum Water Inlet Temp.	108	108	108	108	108
Nominal Power Required (Watts)	2400	2830	3700	5400	6600
A/C Power	230v 60Hz 1Ph	230v 60Hz 1Ph	230v 60Hz 1Ph	230v 60Hz 1Ph	230v 60Hz 1Ph
Max. Circuit Breaker	20	40	60	60	60
Min. Circuit Ampacity	14.4	24	36	35	36.2

Description	Summit/EasyTemp/HeatMaster/EnergyTherm Specifications					
	SUM25TA HML50TA HCB50BTA	SUM3TA HML65TA HCB65BTA	SUM4TA HML80TA HCB80BTA HET80BTA	SUM5TA HML110TA HCB110BTA HET110BTA	HML125TA HCB125BTA HET125BTA	SUM8TA
Model number	SUM25TA HML50TA HCB50BTA	SUM3TA HML65TA HCB65BTA	SUM4TA HML80TA HCB80BTA HET80BTA	SUM5TA HML110TA HCB110BTA HET110BTA	HML125TA HCB125BTA HET125BTA	SUM8TA
Refrigerant Type	R-410A	R-410A	R-410A	R-410A	R-410A	R-410A
Factory Charge	3 LBS. 0 OZ.	3LBS. 11 OZ.	3 LBS. 12 OZ.	5 LBS. 5 OZ.	5 LBS. 12 OZ.	5 LBS. 13.5 OZ.
Factory Test Pressure	440 PSIG	440 PSIG	440 PSIG	440 PSIG	440 PSIG	440 PSIG
Compressor Amps	10.5	21	26.3	27	27	27
Compressor LRA	60	115	150	145	145	145
Fan Amps	1.3	1.3	1.3	2.4	2.4	2.4
Fan LRA	2.8	2.8	2.8	4.3	4.3	4.3
Minimum Water Flow	30	30	30	30	30	30
Maximum Water Flow	75	75	75	75	75	75
Maximum Water Inlet Temp.	108	108	108	108	108	108
Nominal Power Required (Watts)	2400	3130	3930	5600	6600	6600
A/C Power	230V 60Hz 1Ph	230V 60Hz 1Ph	230V 60Hz 1Ph	230V 60Hz 1Ph	230V 60Hz 1Ph	230V 60Hz 1Ph
Max. Circuit Breaker	20	40	60	60	60	60
Min. Circuit Ampacity	14.4	27.6	34.2	36.2	36.2	36.2

# Flow Chart PS/FLo

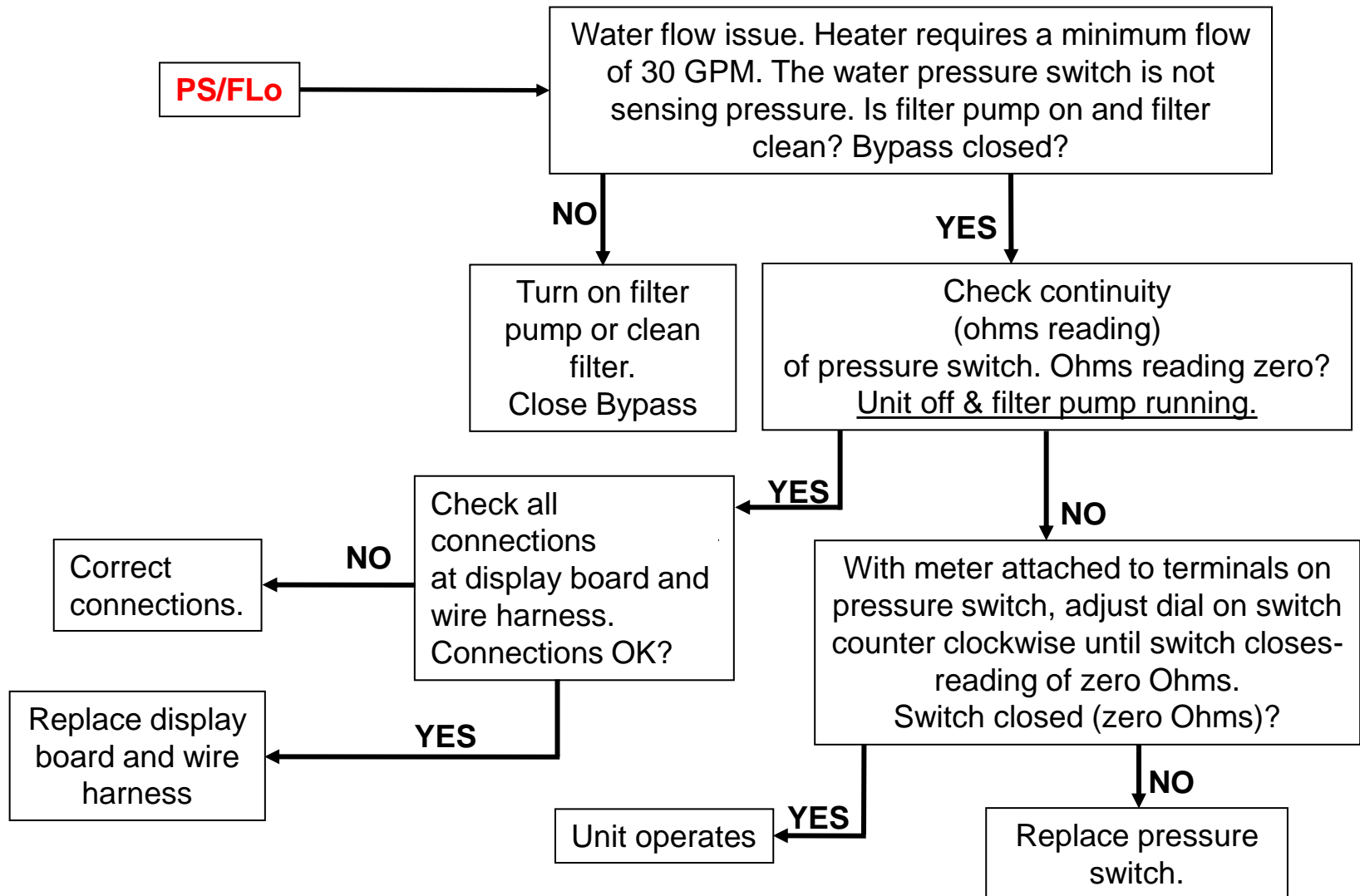

**Note:** Always check operation of pressure switch by turning off pool pump after adjusting pressure switch.  
**Heat pump should cut off when pool pump is not running.**

# Flow Chart HI/HP

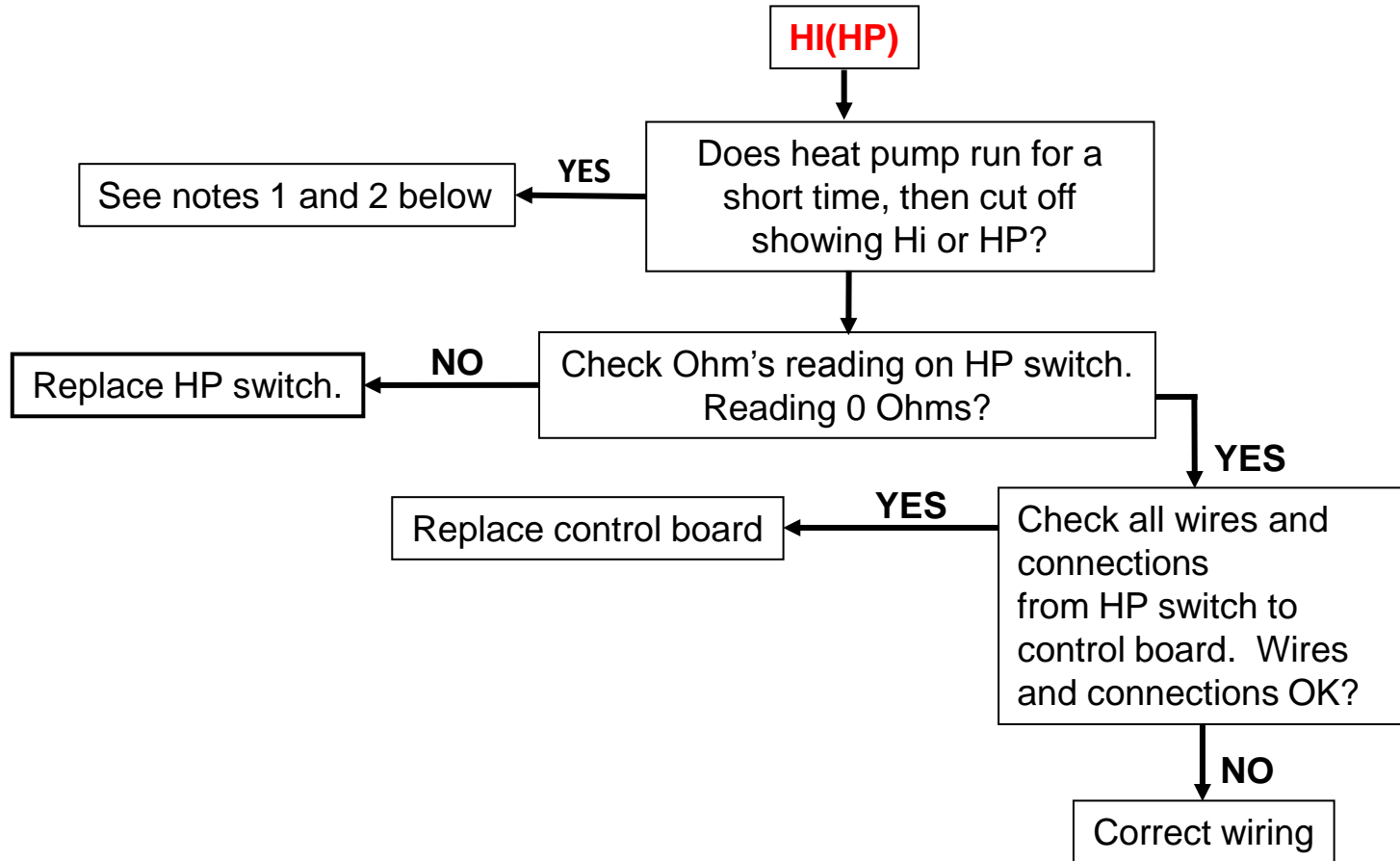

## Note 1

Heater runs for a while then shuts off and shows 'HI or HP' on display. Low water flow is normally the problem. Check filter and pump. A common problem when running unit on spa exists when spa temperature of about 100° F is reached and the unit shuts off with the 'HI or HP' fault. At higher outdoor and water temperatures a higher flow rate may be required for proper operation. The unit requires a minimum of 30 GPM, but may require more under these conditions.

## Note 2

HI/HP after the heat pump has run for a few seconds could be an indication of a failed TXV. If the failure is caused by the TXV, the low side (suction) pressure will fall rapidly once the compressor is running, and the high side (head) pressure will rise rapidly above 590 PSI.

# Flow Chart **OP/PO – SH/Pc**

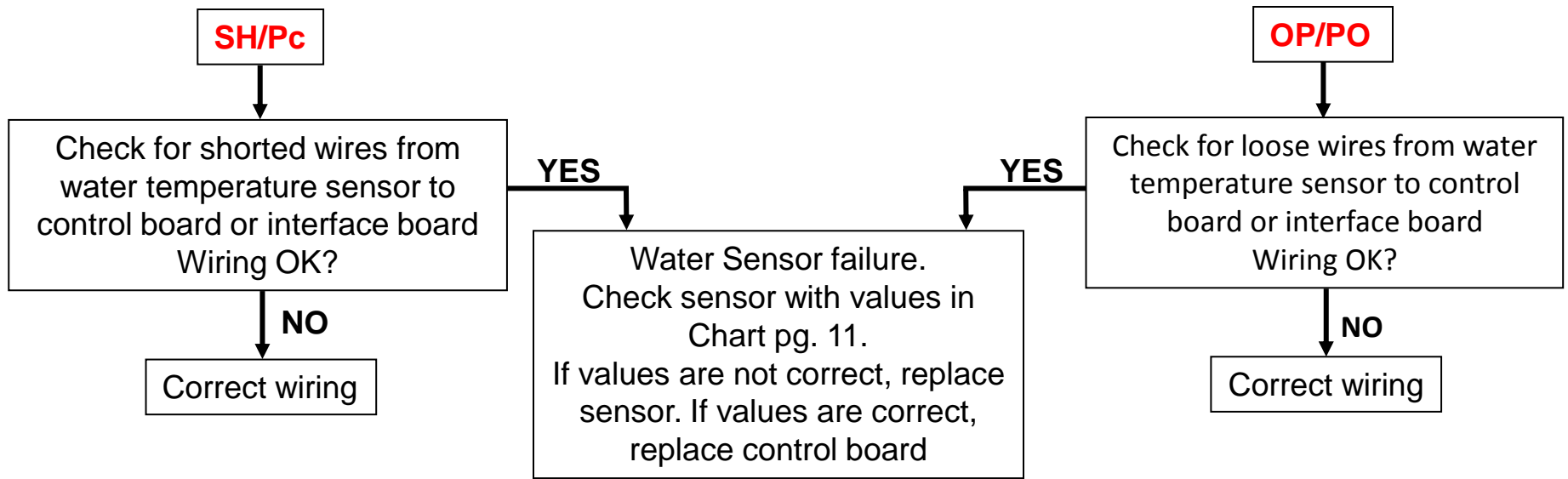

# Flow Chart **cOP/dPO – cSH/dPc**

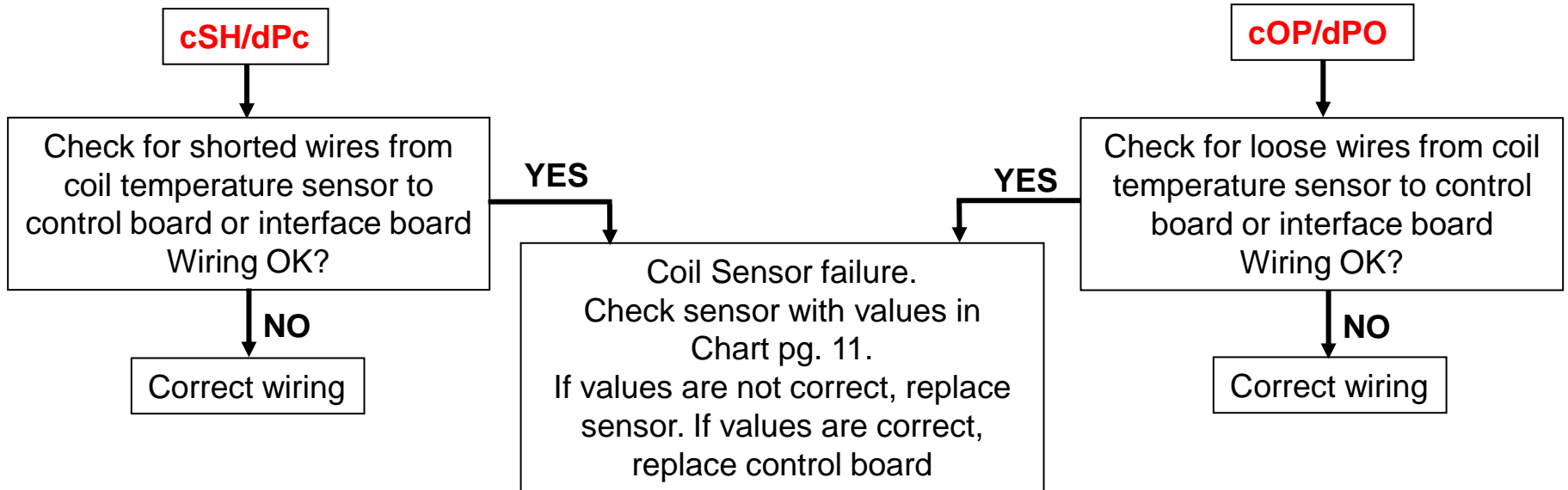

# Flow Chart LP

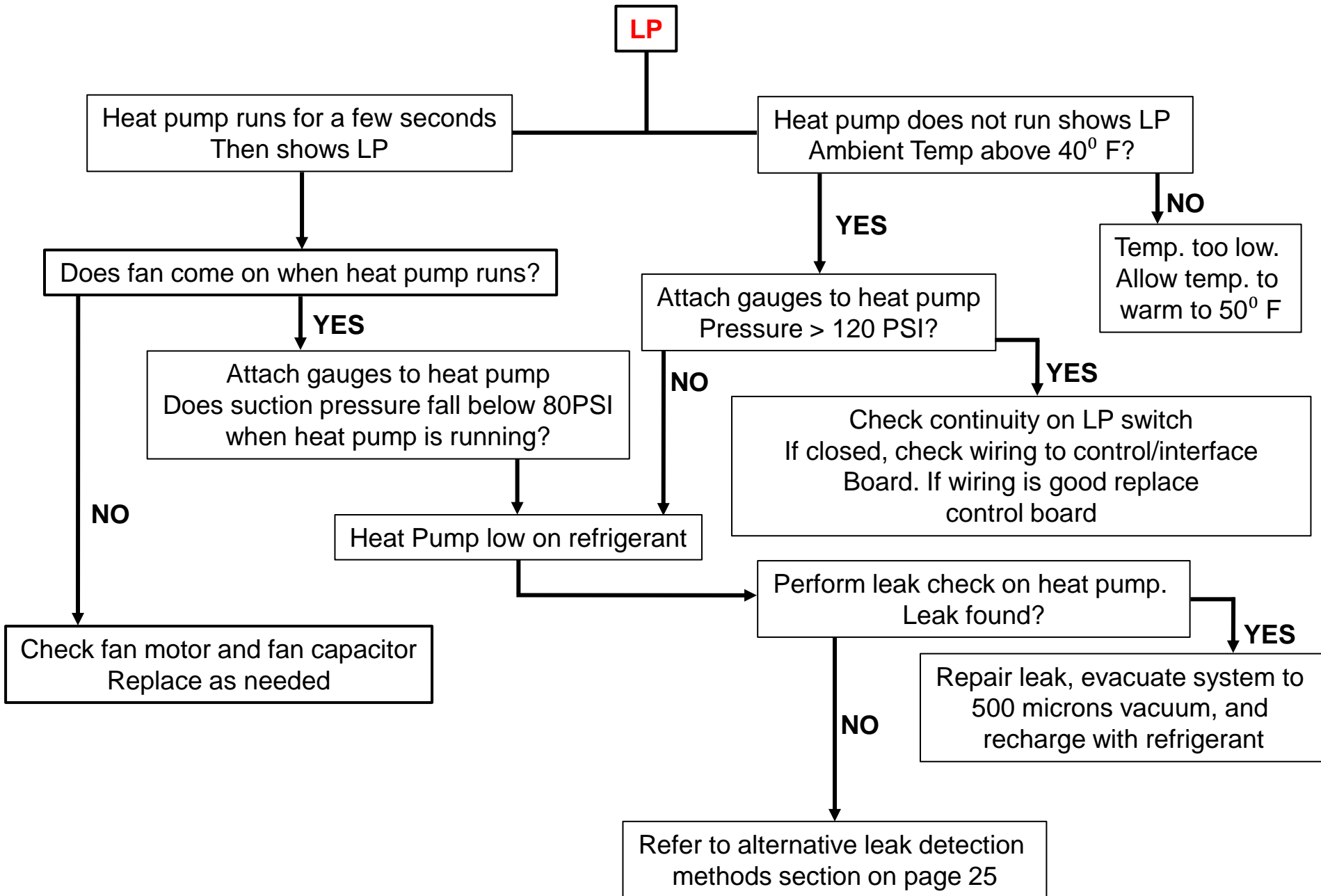

# Alternative Leak Detection Methods

As our industry has evolved the issues we see with heat pumps today have become more diverse and complex. It requires more than a set of gauges and a VOM to diagnose many of these problems.

One of the areas where new techniques and tools are required is in finding refrigerant leaks, particularly on R-410A systems. Due to the high operating pressures of this refrigerant it is possible to have a refrigerant leak that eludes a hand held Halon type leak detector. The leak rate may be significantly less when the heat pump is off (the only time you can properly “sniff” the unit) than it would be when the heat pump is operating.

**A second proven method** of finding leaks is to pressurize the system with nitrogen and use a liquid leak detector such as Big Blue to detect leaks. The maximum pressure you can use in this method is on the data plate of all heat pumps. This is the pressure Hayward pressurizes the system to during manufacture. The majority of leaks can be found using one or both of these methods.

Unfortunately, at times a leak may still remain elusive, even at the hands of the best technician.

**A third proven method** is to inject a fluorescent dye into the system and use an ultraviolet light to detect the leak. We would recommend this method after attempting to discover the leak using the two methods outlined above. Given the sophistication of today’s systems as well as the compact designs we believe that having a dye system leak detector is a requirement in your tool box. If you do not have a dye injector/ UV light detector kit you will need to purchase one. You should be able to purchase a Spectronics kit that contains the UV light, UV protective glasses, cleaner, and enough dye for at least 2 systems for around 100.00 U.S.