

Engineering Base

Configuration of Terminal Block Diagram

October 2018

AUCOTEC AG

Oldenburger Allee 24
D-30659 Hannover
Phone: +49 (0)511 61 03-0
Fax: +49 (0)511 61 40 74

www.aucotec.com

AUCOTEC, INC.

17177 North Laurel Park Drive,
Suite 437
Livonia, MI 48152
Phone: +1 630 485 5600
Fax: +1 248 655 7800

Copyright: All rights, especially the right of reproduction and distribution as well as translation, are reserved. No part of this book may be reproduced, stored in retrieval system, or transmitted in any form or by any means, electronic, mechanical, photocopying, microfilming, recording, or otherwise, without prior permission from **AUCOTEC AG**.

Exclusion of liability: Texts and software have been prepared with the greatest of care. The publishers as well as the authors cannot assume any legal or other liability of any nature for potential faulty statements and their consequences, which shall apply also for the software potentially included.

Trademarks Engineering Base® is a registered trade mark of the AUCOTEC AG, Germany. Microsoft Office Visio®, Microsoft SQL Server and Windows® are registered trademarks of Microsoft Corporation, USA.

Contents

1	General	1
2	Graphic Changes	2
2.1	Lines	2
2.2	Texts.....	2
2.3	Graphics and Images	3
2.4	Logos.....	3
3	Logical Changes (via XML)	4
3.1	Starting the Assistant	4
4	Logical Changes (via the Graphic Template)	6
4.1	Starting the Assistant.....	6
4.2	Attributes	7
4.2.1	Fixed Attributes	7
4.2.2	Freely Definable Attributes	7
4.3	Red Frames.....	7
4.4	Parameter.....	11
5	Terminal Block Diagrams	13
5.1	Standard Terminal Block Diagram	13
5.2	Rotated Terminal Block Diagram	14
5.3	Power PTD with 15-Cable Matrix	18
5.3.1	The Cable Table.....	19
5.3.2	The Wiring Material	21
5.3.3	The Terminal Types.....	22
5.4	Accessory in the Terminal Block Diagram	23
5.5	Power PTD without Cable Matrix	24
5.6	Multi-Column Terminal Block Diagram (VBSTB4).....	25
6	Tips and Tricks	27
6.1	Making a Copy	27
6.2	Editing in the Full-Screen Mode	27
6.3	Save.....	27
7	Settings in the XML File.....	28
7.1	Formatting Attribute Texts	28

7.2	Cutting Rules for Destination Information	30
7.3	Separators in the Destination Designation.....	31
7.4	Separators in the Target Pin Designation	31
7.5	Pin designation.No Cable Matrix	31
7.6	Changing the Sorting of the Terminals in the Terminal Block Diagram	31
7.7	Suppressing Blank Spaces when Displaying External and Internal Destinations	31
7.8	Jumper Representation without Endpoints	32
7.9	Representation of Terminal Material in Several Columns	32
7.10	Graphic Representation of Switches	32
7.11	Representation of Master-Shapes in the Foreground	33
7.12	Display of the Cross-Reference for Unconnected Terminals	33
7.13	XML Commands	33
8	Settings in the Graphic.....	34
8.1	Overview of the Attributes and Parameters in the Terminal block diagram Template.....	34
9	List of the Attributes	35
9.1	Terminal Blocks	35
9.2	Segments.....	36
9.3	Terminals and Destinations	36
9.4	Cables.....	41
9.5	Tables.....	42
10	List of Parameters	43
10.1	Bridges	43
10.2	Cables.....	44
10.3	Display.....	44
10.4	Control.....	46
11	Red Frames	47
12	XML Commands Defining the Layout of the Terminal Block Diagram	48

1 General

The Engineering Base terminal block diagram is a special template showing information about terminal blocks, terminals and their accessories. The terminal block diagram is generated via an assistant and maps information from the data model.

There are two methods for creating a terminal block diagram:

- Start via the menu item **Multi Terminal Block Diagram** in the folder **Equipment**.
- Start of the desired report from a terminal block.

This document describes how to change the display of this data. The changes are both graphic and logical. Certain parameters can influence the output of information in the terminal block diagram; the logical algorithms of the assistant remain unchanged, however!

In principle, a project may contain several terminal block diagram templates. The templates are stored in the folder **Templates\Sheets**.

2 Graphic Changes

Graphic changes are always made in the respective template using Visio; for this purpose open the corresponding template in Visio. As a general rule, all changes described in the following are carried out on a special level.

This level is called **FORM** and is unlocked via the **Layer Properties**.

Layer Properties						
Name	#	Visible	Print	Active	Lock	Snap
0	0	<input checked="" type="checkbox"/>	<input checked="" type="checkbox"/>	<input type="checkbox"/>	<input type="checkbox"/>	<input checked="" type="checkbox"/>
CONNECTION	0	<input checked="" type="checkbox"/>	<input checked="" type="checkbox"/>	<input type="checkbox"/>	<input type="checkbox"/>	<input checked="" type="checkbox"/>
Current Path	0	<input type="checkbox"/>	<input type="checkbox"/>	<input type="checkbox"/>	<input type="checkbox"/>	<input checked="" type="checkbox"/>
DYNAREACUR	0	<input checked="" type="checkbox"/>	<input checked="" type="checkbox"/>	<input type="checkbox"/>	<input type="checkbox"/>	<input checked="" type="checkbox"/>
DYNAREADEF	0	<input type="checkbox"/>	<input type="checkbox"/>	<input type="checkbox"/>	<input type="checkbox"/>	<input checked="" type="checkbox"/>
FORM	282	<input checked="" type="checkbox"/>	<input checked="" type="checkbox"/>	<input type="checkbox"/>	<input type="checkbox"/>	<input checked="" type="checkbox"/>

Once the level is unlocked, you can there place or change elements.



For newly inserted graphics, the assignment to the **FORM** level must be made individually. It is easier to copy existing elements and replace the graphic.

Once you have made all adjustments, the **FORM** level is to be locked again via the layer properties.



Do not use the form to make changes the report.

2.1 Lines

In general, you may use all line styles and types in the template. The lines entered here are always shown in the finished report or the printout, as opposed to certain dividing lines and e.g. bridges.

2.2 Texts

Except for attribute texts, you can freely and individually adapt all texts in the template. All colors, sizes and fonts are permitted. If the terminal block diagram is to be multilingual or is to be generated in the language of the country in question, then you must use text blocks with dictionary texts from Engineering Base.

The only texts that cannot be changed with the usual Visio logic are attribute texts (marked red in the figure in chapter 8.1, [Overview of the Attributes and Parameters in the Terminal block diagram Template](#)). These can only be changed in the XML configuration. This is described in chapter 7.1, [Formatting Attribute Texts](#).

2.3 Graphics and Images

Explanatory graphics and images may be inserted in the template. Like all other graphic elements, these must be assigned to the level **FORM**.

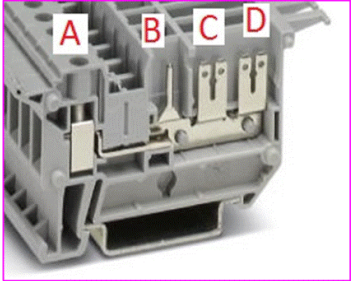
1		2			3		4		
No.	Cable	Bel. Adern: Blatt \ insg.			Cable-Type	Diam.	Core		
									
Pin cable-core									
		A	B	C	D				
Back-reference	No.								destination identifier extern
	1	2	3	4	5	6	7	8	9
		Pot	A	B	C	D	No.		

Example of an embedded image

2.4 Logos

You should not use the terminal block diagram template to store your own or customer logos. These are better placed in a form and can thus easily be changed throughout the project.

3 Logical Changes (via XML)

To change certain settings for graphic and/or logical variants of the terminal block diagram, it may sometimes be necessary to change the configuration via assistant. This should always be done with great care since small syntax errors may result in terminal block diagram malfunction.

3.1 Starting the Assistant

How to execute the assistant

1. Use the **Engineering Base Explorer** to select the terminal block diagram template of your choice.
2. In the context menu, choose **Select Assistant**, select the assistant **Terminal Block Diagram - Configuration** and click on **Run**.

Once the assistant is started, the configuration is displayed in the terminal block diagram configuration editor.

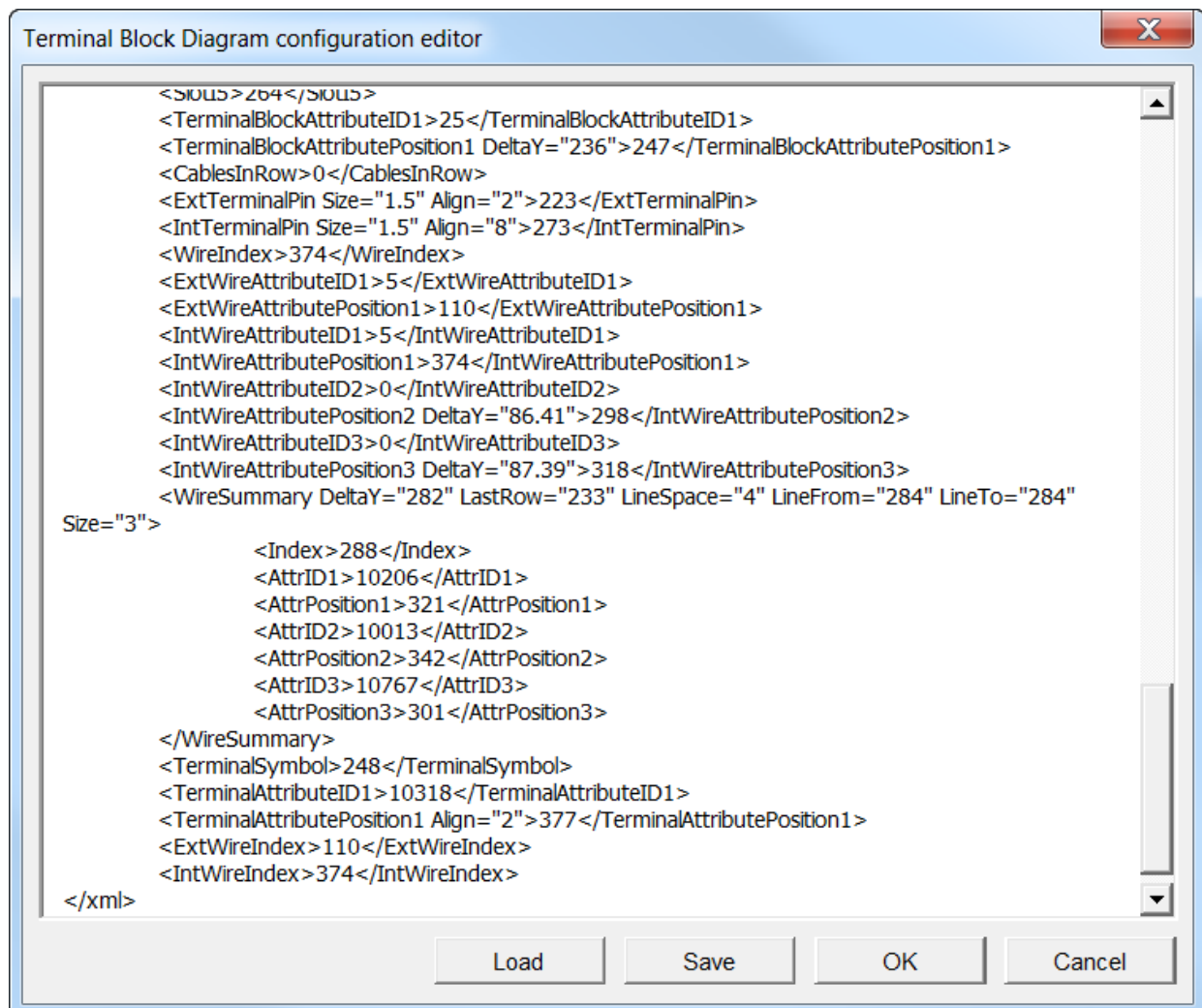

Terminal Block Diagram configuration editor

The **Load** button loads a configuration from a memory location, and **Save** stores the current configuration in an XML file. With **OK** you write the settings back into the template, and **Cancel** aborts the procedure.



We recommend that you transfer the complete contents of the configuration to an XML compatible editor (Notepad++ or similar), carry out the adaptation there and copy back the complete contents of the terminal block diagram configuration editor.

```
<IntTerminalPin Font="ISOCPEUR" Align="8" DeltaY="-283.841">279.51486</IntTerminalPin>
<WireIndex>374</WireIndex>
<IntWireAttributeID1>5</IntWireAttributeID1>
<IntWireAttributePosition1 Font="ISOCPEUR" DeltaY="-334.221">193.93383</IntWireAttributePosition1>
<IntWireAttributeID3>0</IntWireAttributeID3>
<IntWireAttributePosition3 DeltaY="87.39">318</IntWireAttributePosition3>
<WireSummary DeltaY="282" LastRow="232" LineSpace="4" LineFrom="362" LineTo="414" Size="4">
  <Index Font="ISOCPEUR">362.71134</Index>
  <AttrID1>10206</AttrID1>
  <AttrPosition1 Font="ISOCPEUR" DeltaY="25.81">282.44447</AttrPosition1>
  <AttrID2>10013</AttrID2>
  <AttrPosition2 Font="ISOCPEUR" DeltaY="32.81">306.44447</AttrPosition2>
  <AttrID3>10767</AttrID3>
  <AttrPosition3 Font="ISOCPEUR">384.43413</AttrPosition3></WireSummary>
<TerminalSymbol>282.64447</TerminalSymbol>
<TerminalAttributeID1>25</TerminalAttributeID1>
<TerminalAttributePosition1 Font="ISOCPEUR" Align="2" DeltaY="-323.841">182.14598</TerminalAttributePosition1>
<IntWireIndex Font="ISOCPEUR" DeltaY="-313.841">205.6391</IntWireIndex>
<ConnectPotentialByBridge>0</ConnectPotentialByBridge>
<NewColumnForSubCables>1</NewColumnForSubCables>
<ExtNodePotential Font="ISOCPEUR" DeltaY="-204.221">102.62058</ExtNodePotential>
<TerminalRepresentationOptions>0</TerminalRepresentationOptions>
<FunctionSeparator><![CDATA[ ]]></FunctionSeparator>
<LocationSeparator><![CDATA[ ]]></LocationSeparator>
<SortTerminalOptions>0</SortTerminalOptions>
<BridgeOptions>0</BridgeOptions>
```

After carrying out all changes, terminate editing with **OK**; the template is now ready for use.

4 Logical Changes (via the Graphic Template)

Particularly when making graphic changes in the terminal block diagram, you should do this in coordination with the changed graphic. For this purpose open the template in a special way via assistant. Graphic changes are not permitted at this point, the changes made are stored in the template and in the XML configuration file.

Some elements cannot be influenced graphically; here the assistant restores the former values upon storage. This relates to bridges and to the Y-coordinates of the red frames.

4.1 Starting the Assistant

How to execute the assistant

1. Use the **Engineering Base Explorer** to select the terminal block diagram template of your choice.
2. In the context menu, choose **Select Assistant**, select the assistant **Terminal Block Diagram - Open Template** and click on **Run**.

After starting the assistant, the template is shown in Visio and the possible settings (attributes, values, tables) become visible.

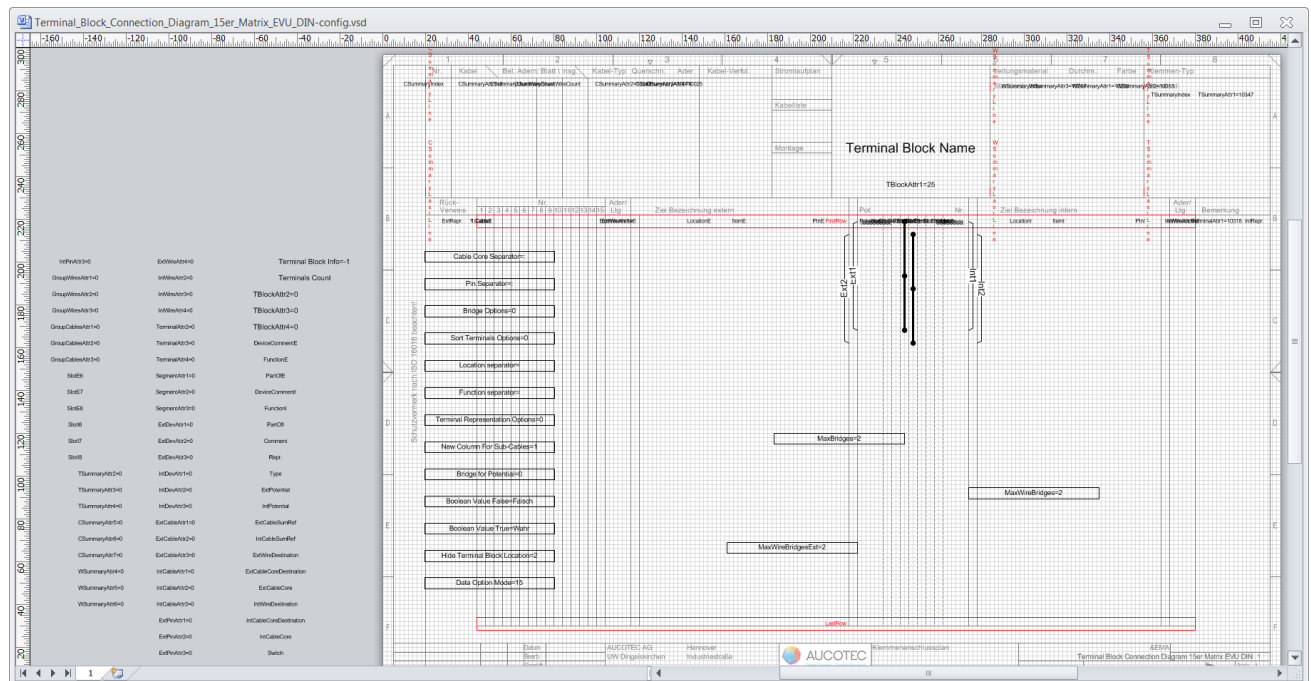

Opened terminal block diagram template

The opened template now shows all elements that can be adapted or changed. There are different kinds of attributes, tables and parameters, which are described in the following.



Only the attributes and tables placed in the drawing are taken into account for terminal block diagram creation. All attributes outside of the drawing area are inactive.

If changes have been made and recognized, then upon closing Visio the following message is displayed:

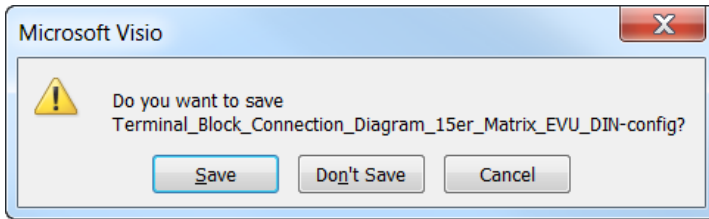

Message after finishing editing

Save stores the changes in the template, **Don't Save** discards the changes, and **Cancel** returns to editing.

4.2 Attributes

4.2.1 Fixed Attributes

Fixed attributes are characterized by the lack of "=" and a lacking number after the attribute name. The attribute names are invariable and represent the contents of a terminal, wire or cable attribute.

TSummaryIndex

Example of a fixed attribute

4.2.2 Freely Definable Attributes

Freely definable attributes are characterized by a "=" and a number after the attribute name. The attribute names are invariable and represent a selectable content of a terminal, wire or cable attribute.

TSummaryAttr1=10347

Example of a freely definable attribute

With these attributes, only the value following the "=" character may be changed, after a double click on the attribute.



4.3 Red Frames

Red frames mark the field size (e.g. a line height or the space required by a cable entry). The insertion points result from the frame positions and those of the individual attributes. The attributes are assigned to their appropriate lines via their names.

For each "FirstRow" and "SummaryLine" respectively there always is a "LastRow" and "SummaryLastLine" respectively; these mark the beginning and end of a line area and should always be placed on top of each other. The "LastRow" and "SummaryLastLine" respectively also control the page change; i.e. when this marker is reached, the assistant creates a new page (a new TAB) in the terminal block diagram.

If the red frames is realized as rectangle, then later on in the terminal block diagram a black line is drawn on the lower red line.

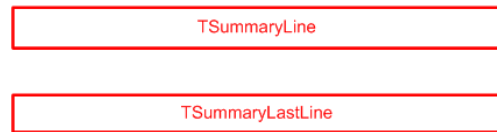
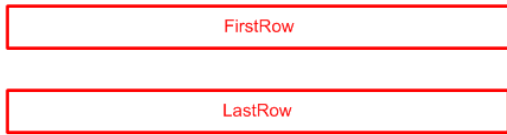

Example: First/Last Row

Example: TSummaryLine/TSummaryLastLine

You can graphically influence this black line depending on the element to be represented. This can only be done in the XML file via the configuration. For terminals and terminal segments, the following settings are possible.

General Settings for Lines

<RowLine Weight="0.25" Style="1"/>

The value must be specified in mm, separated by a dot. For Style you may enter the values shown below (selection of the Visio lines).

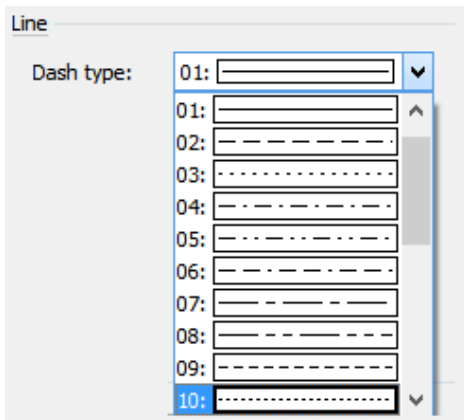

Settings for Terminal Segment

<RowLineSegment Weight="0.15" Style="1"/>

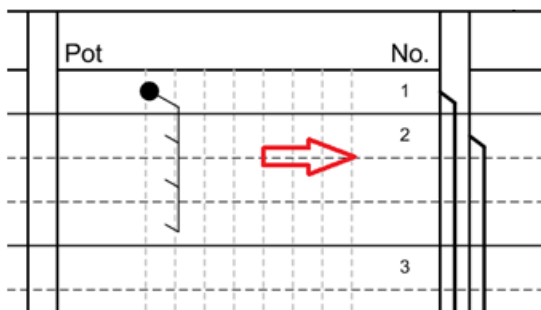

Settings for Terminals

`<RowLineDestination Weight="0.15" Style="2"/>`

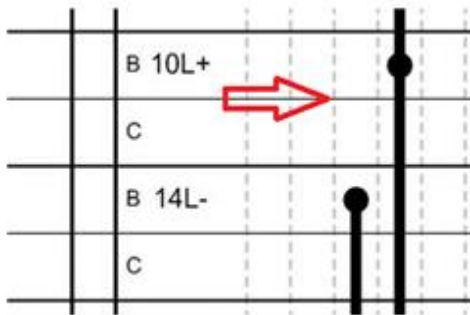

If the red frames is collapsed to a vertical line, then the line under the line is left out in the final terminal block diagram.

W
S
u
m
m
a
r
y
L
i
n
e

W
S
u
m
m
a
r
y
L
a
s
t
L
i
n
e

CableWidth

CableAttr=10347
HeaderCablePos

Example: WSummaryLine/WSummaryLastLine

Example: Box CableWidth

Exception Frame "Cable Width"

An exception is the frame **CableWidth**. Its size determines the column width of the cable table and its position defines, where the respective arrows will be entered.



Example: CableWidth

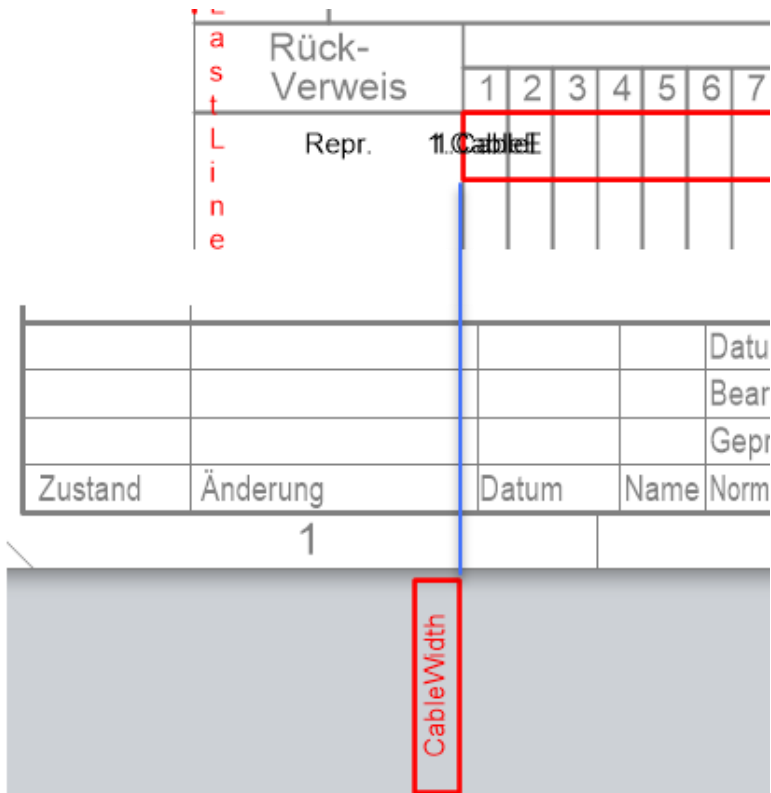

Relationship Position and Size CableWidth

The red frame is located left besides the guide of the column where the first core entry is carried out. From this position onwards, the entries are made towards the right. Besides, the size of the frame defines the width of column.

4.4 Parameter

Black borders mark settable values to which the assistant **Terminal Block Diagram** later on reacts. The position is relevant only for particular specifications, changes are realized by a double click on the entry.



Example: Settable parameters

The positions of the following parameters influence their representation in the terminal block diagram.

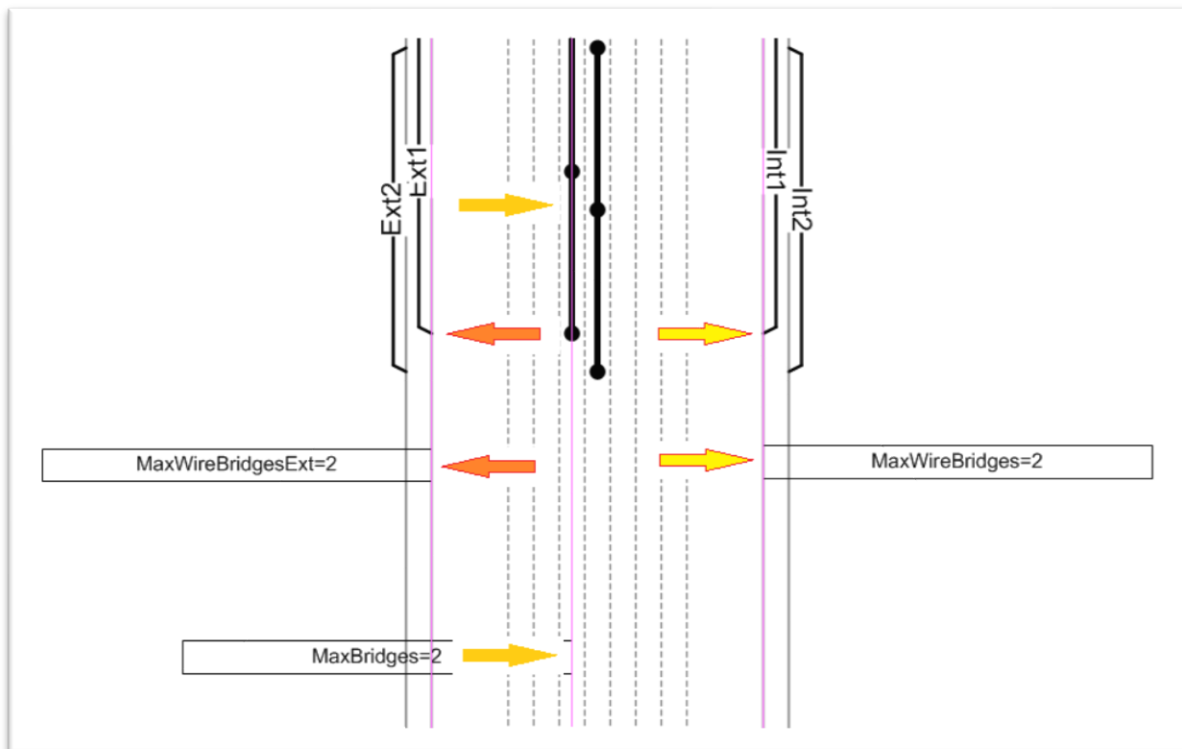

Positions of the bridges and the parameters

For the Y coordinates of the parameters **MaxBridges**, **MaxWireBridgesExt** and **MaxWireBridges** the position of the graphic is crucial for the bridges, the bridge graphic therefore influences the Y position of the respective parameter.

The graphics used here for the bridges are at present unalterable, their number is specified via the parameters. You can change the graphics for the internal and external bridges only in the X direction; the upper point of the bridge must lie in the red table **First Row**.

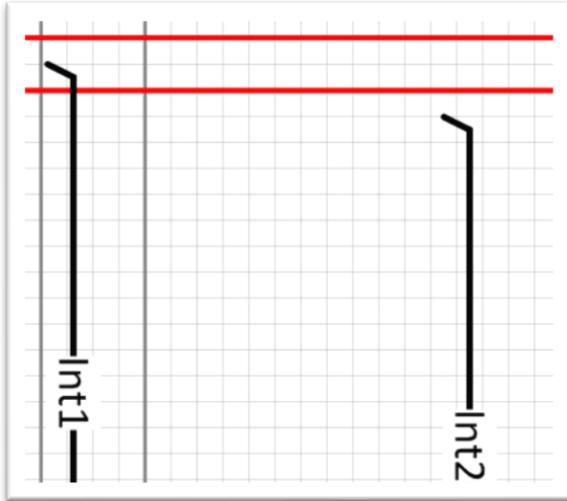

Position of the second, internal bridge

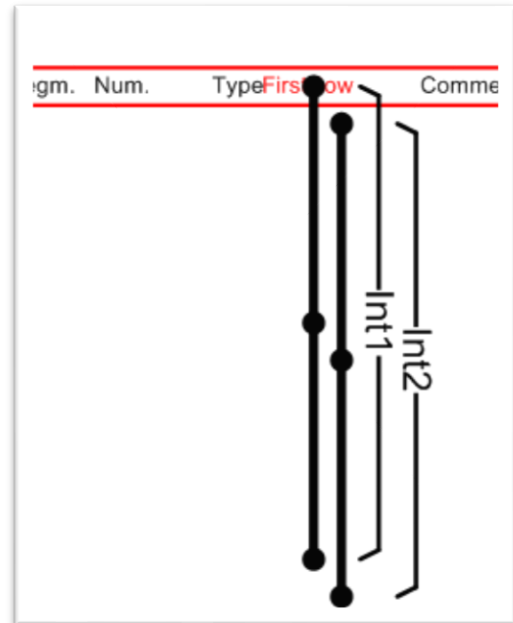

Example: Positions of the bridges

After storage, the assistant **Terminal Block Diagram - Configuration** autonomously corrects the settings concerning the positions of the bridges and of the parameters. If e.g. more than two bridges are to be displayed, then only the value of the parameter is to be increased, the graphic is derived from the arrangement of the two bridges.

5 Terminal Block Diagrams

5.1 Standard Terminal Block Diagram

In Engineering Base, the standard terminal block diagram is created in the DIN A3 landscape format. The left-hand area of the terminal block diagram maps the external side of the terminal and the right-hand area the internal side. Externally, maximally 8 cables may be connected, internally maximally 5; external bridges are not shown.

The cables in this terminal block diagram are arranged in columns and lines. The figure below shows the basic mechanisms, and on the right the final result in the terminal block diagram.

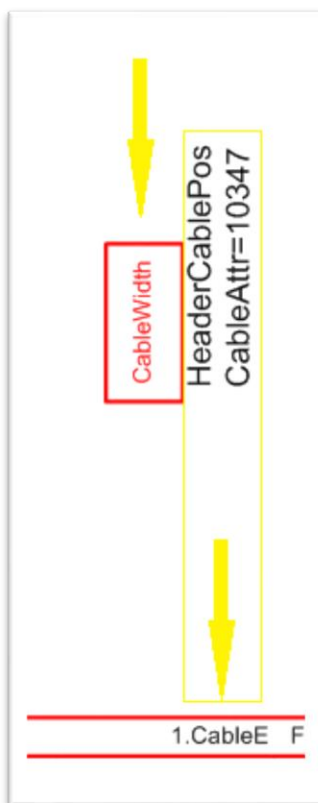

Cable definition template

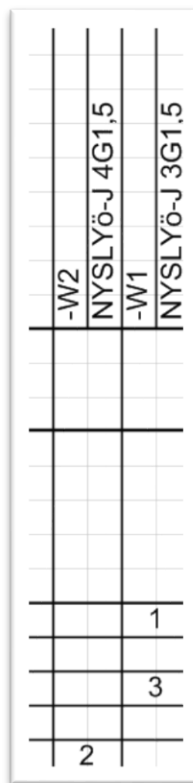

Example: cable representation in a standard terminal block diagram

The red box **CableWidth** shows by means of its size how the two attributes are displayed. The position to the left of the attributes specifies that the cables are entered from right to left. If the red box were positioned to the right of the text attributes, then the cables would be entered from left to right.

The cable attributes (**HeaderCablePos** and **CableAttr=10347**) themselves correspond to the entries **1.CableE** and **1.CableI**, the individual cores of the cable are thus listed under the cable.

5.2 Rotated Terminal Block Diagram

If the terminal block diagram is to be created not in the landscape but the portrait format (DIN A3 portrait), then the template must accordingly be built from left to right.

In any case a template should always be used as basis, from Engineering Base version 6.5.2 onward this is part of a standard project. You can carry out all graphic adjustments as described above.

- [-] [Icon] Standard
 - [+] [Icon] Equipment
 - [+] [Icon] Functions
 - [+] [Icon] Documents
 - [+] [Icon] Tasks
 - [+] [Icon] Messages
 - [-] [Icon] Templates
 - [-] [Icon] Sheets
 - [-] [Icon] Favorites
 - [+] [Icon] A0 Landscape
 - [+] [Icon] A1 Landscape
 - [+] [Icon] A2 Landscape
 - [+] [Icon] A3 Landscape
 - [+] [Icon] A3 Landscape Functions
 - [+] [Icon] A3 Landscape, 2mm Grid
 - [+] [Icon] A3 Landscape, Scale 1:10
 - [+] [Icon] A3 Portrait
 - [+] [Icon] A4 Landscape
 - [+] [Icon] A4 Portrait
 - [+] [Icon] Auto Create Data Sheet
 - [+] [Icon] Auto Create Data Sheet Device
 - [+] [Icon] Bill of Material
 - [+] [Icon] CAD Import
 - [+] [Icon] CNC export
 - [+] [Icon] Cable Connection Report
 - [+] [Icon] Cable List
 - [+] [Icon] I/O-Allocation
 - [+] [Icon] Purchase Order
 - [+] [Icon] Sheet Index
 - [+] [Icon] Terminal Block Diagram
 - [+] [Icon] Terminal Block Diagram - rotated
 - [+] [Icon] Unit List
 - [+] [Icon] Wires
 - [+] [Icon] Others

Templates of a standard project

The template **Terminal Block Diagram – rotated** offers a special terminal block diagram; the changes compared to the standard are described in the following. If you edit the template with the assistant **Terminal Block Diagram – Open Template**, the first thing to become conspicuous is the position of the **FirstRow** and the **LastRow**. These are positioned horizontally on top of each other, however in contrast to the terminal block diagram the **LastRow** lies above the **FirstRow**.

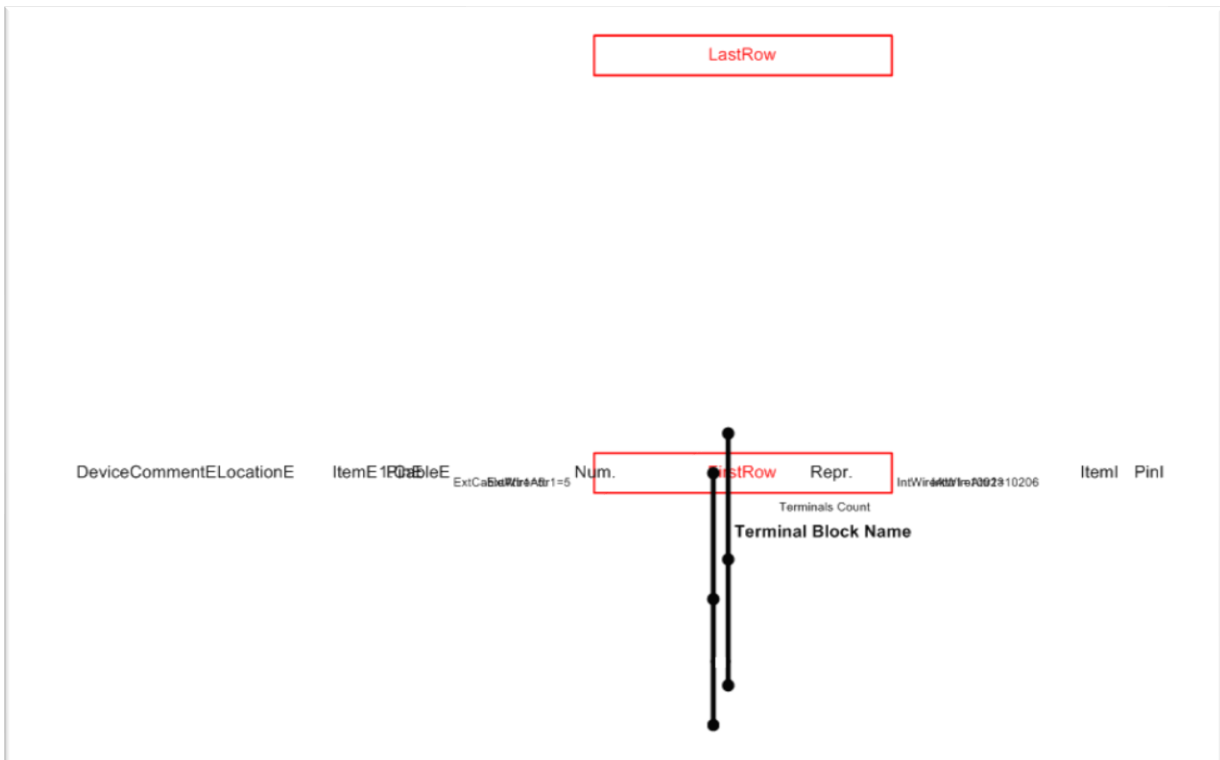

Arrangement of the attributes and the tables **FirstRow** and **LastRow** in the template

The graphic here only serves as basis for the representation, the information for the precise positioning of the attributes and tables is taken from the configuration file. The most important precondition is the specification of `<Rotated>1</Rotated>` in the XML file of the template.

To position the terminal line, e.g. the following settings must be made directly in the XML configuration file.

```
<RowHeight>8</RowHeight>           <!-- Height of terminal line -->
<FirstRowPos>60</FirstRowPos>       <!-- X-coordinate for first line -->
<LastRowPos>390</LastRowPos>        <!-- X-coordinate for last line -->

<RowLineMinPos>148</RowLineMinPos>  <!-- Y-Min-coordinate for first line -->
<RowLineMaxPos>208</RowLineMaxPos>  <!-- Y-Max-coordinate for last line -->
```

Settings in the XML file

Here you should make sure that the coordinates refer to the final placement of the terminal line in the terminal block diagram and not to the position in the template. The line height **RowHeight** is 8 mm, in the first line **FirstRowPos** the center of the line is to be specified as insertion position at 60 mm. The last line **LastRowPos** is placed at 390 mm. The lines for the terminal line start at Y=148 mm, extend to Y=208 mm and are 8 mm in height.

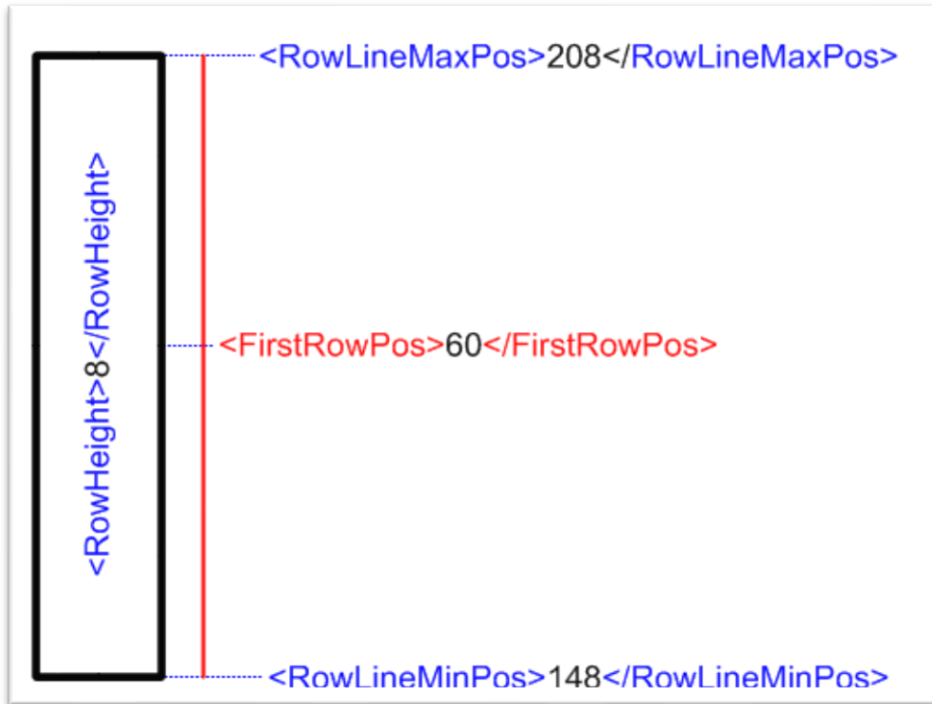

Positions of the values in the graphic

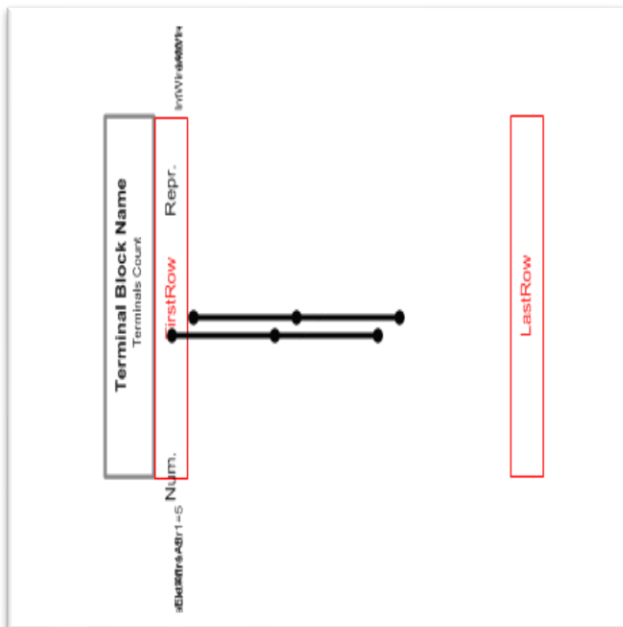

Intended result in the template

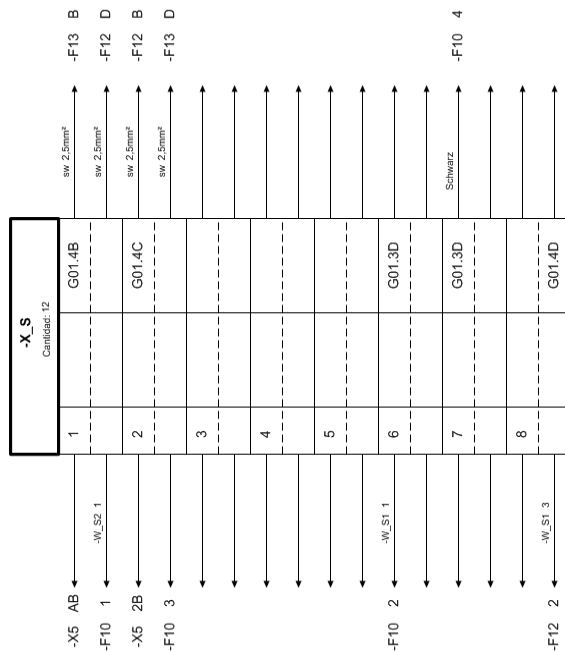

Example: terminal block diagram

A peculiarity of the rotated template is the display of lines with arrows to the left and right of the terminal line. This is achieved with the following entry in the XML file.

```
<Lines>
  <Line StartX="148" EndX="148" />
  <Line StartX="160" EndX="160" />
  <Line StartX="184" EndX="184" />
  <Line StartX="208" EndX="208" />

  <Line StartX="114" EndX="148" MarkBegin="4" Condition="External" />
  <Line StartX="208" EndX="242" MarkEnd="4" Condition="Internal"/>
</Lines>
```

Entering lines

The first block contains the start value of each of the lines shown in the terminal line that delimit them to the outside. The second block specifies how long the external and internal lines respectively are drawn and how their ends are represented.

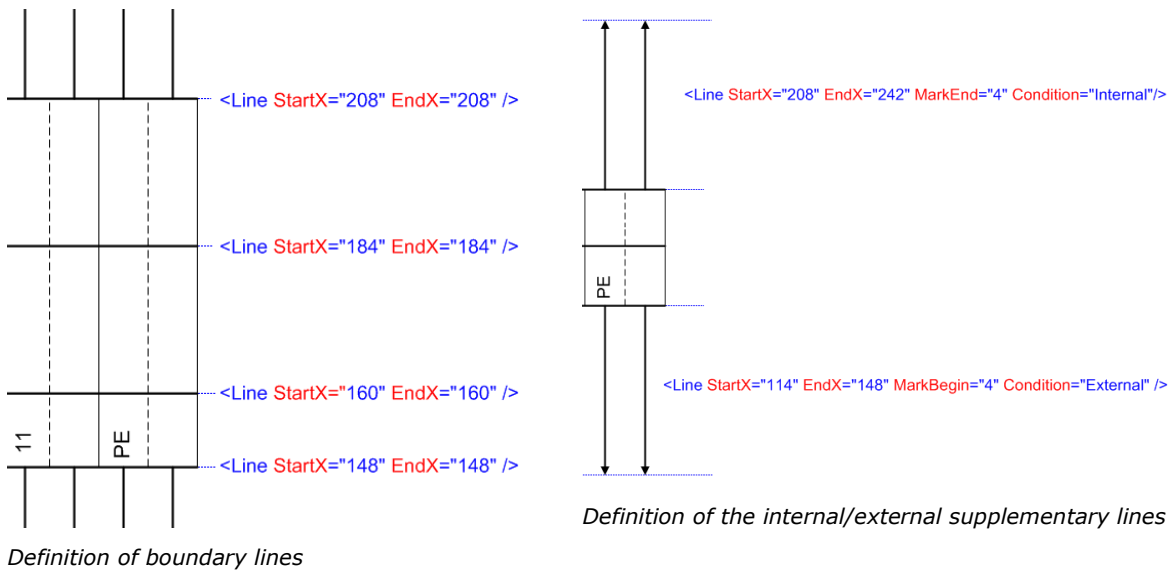

5.3 Power PTD with 15-Cable Matrix

In the Power Generation and Distribution industrial sector, a certain type of terminal block diagram in the DIN A3 landscape format has become established; this terminal block diagram type has some peculiarities.

The cable, wiring and terminal information is here shown in tabular form above the terminal block, and the individual lines only refer to this information. In the lines themselves, the external side is shown on the left and the internal side on the right.

The customary arrangement of the cable as in the standard terminal block diagram is not used here, these elements are outside of the drawing area of the template.

5.3.1 The Cable Table

The table is used to enter maximally 15 cables, if more than 15 cables are to be shown, then a new sheet is created. The operating mode of the tables has already been described in chapter 4.3, [Red Frames](#); here we only explain the interrelations between the table and the individual terminal lines.

No.	Cable	Bel. Adern: Blatt \ insg.															Cable-Type Q
CSummaryIndex																	
Rück-reference	No.															core/Ltg	
	1	2	3	4	5	6	7	8	9	10	11	12	13	14	15		
	1.CableE 1.CableI															ExtWireIndex ExtWireAttr1=5	

Attribute **CSummaryIndex**

The index entries in the table are entered from top to bottom, the entries for the associated cores and wires respectively from left to right. Each line of the cable table refers to a column under **No.**, the column then gets an arrow for each connected core. The direction of the arrow shows whether the cable has been connected externally (<-) or internally (->).

Positioning of the arrows starts with the attribute **1.CableE** and **1.CableI** respectively, the core designations for the external side are entered at **ExtWireIndex** and **ExtWireAttr1=5** respectively. For the internal side the attributes **IntWireIndex** and **IntWireAttr1=5** respectively are analogously positioned on the right of the template.

Important for the display of the arrows is the positioning of the attributes **1.CableE** and **1.CableI**. These have to be located on the same X position, only then the display is affected. This may be achieved using the position window with the correct value or the text position (center horizontally).

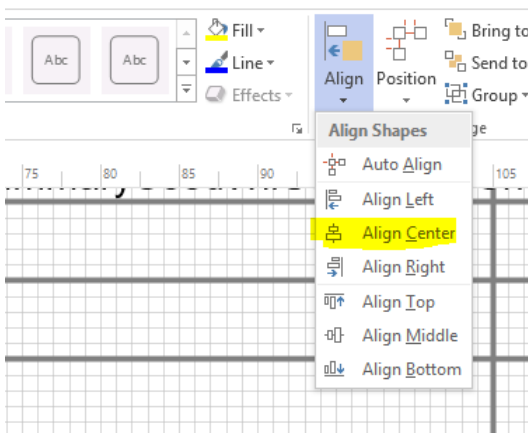
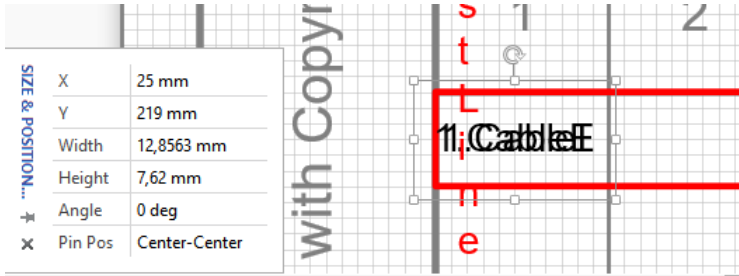

Setting options for the arrows in the EVU cable matrix

No.	Cable	Bel. Adern: Blatt \ insg.		Cable-Type	Qu
1	W100		3	4	
2	W400		1	1	

Rück-reference	No.															core/Ltg
	1	2	3	4	5	6	7	8	9	10	11	12	13	14	15	
2.2B																
2.3A	<															3
	◀															4
	<															1

Example: result in the terminal block diagram

5.3.2 The Wiring Material

In the wiring materials table all wires used for wiring are listed together with their properties. The material used most frequently or defined as standard for the terminal block diagram is listed at the top of the table. Subsequently all other wires are listed, and in the terminal lines references to the wiring material are made.

6	7	
Leitungsmaterial	Diam.:	colour
Standard:	WSummaryAttr3=10767	WSummaryAttr1=10206
WSummaryIndex		
	WSummaryAttr3=10767	
		WSummaryAttr1=10206
		WSummaryAttr2=10013
WSummaryLastLine		

Original tabular representation

6	7	
Leitungsmaterial	Diam.:	colour
Standard:	WSummaryLine	
WSummaryIndex		
	WSummaryAttr3=10767	
		WSummaryAttr1=10206
		WSummaryAttr2=10013
WSummaryLastLine		

Representation of the individual elements

The figure on the left shows the display after calling the assistant, all elements are on the same Y coordinate. The figure on the right shows the beginning and the end of the line and the attributes in staggered form to clarify the information contained in each line. This table is limited by **WSummaryLastLine**, once this marker is reached there is a page change.

6	7	
Wiring Material	Diam.:	Colour
Standard:H07V-K	1,5mm ²	bk
1 H07V-K	2,5mm ²	BK
2 H07V-K	1,5mm ²	BK

Example: filled table

5.3.3 The Terminal Types

The terminal type table lists all types used for this terminal block. The terminal type most frequently present in the block is listed at the top of the table after the text Standard. All other terminal types then follow according to their positions in the block.

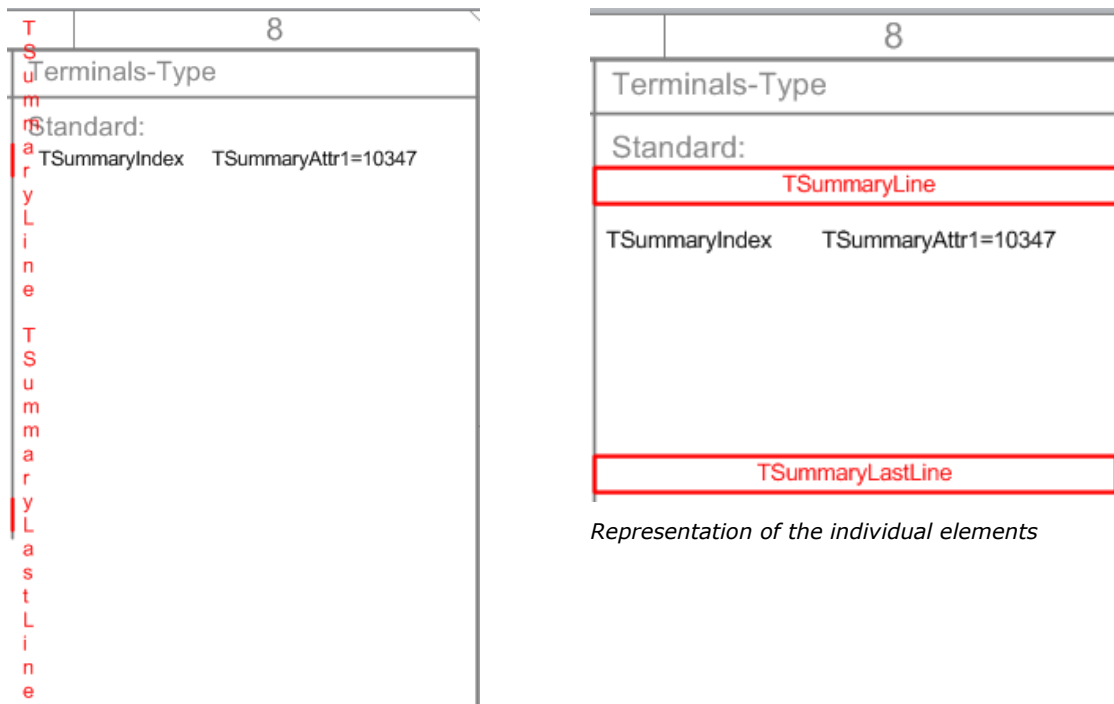

Original tabular representation

The figure on the left shows the display after calling the assistant, all elements are on the same Y coordinate. The figure on the right shows the beginning and the end of the line to clarify the information contained in each line. This table is limited by **TSummaryLastLine**, once this marker is reached there is a page change.

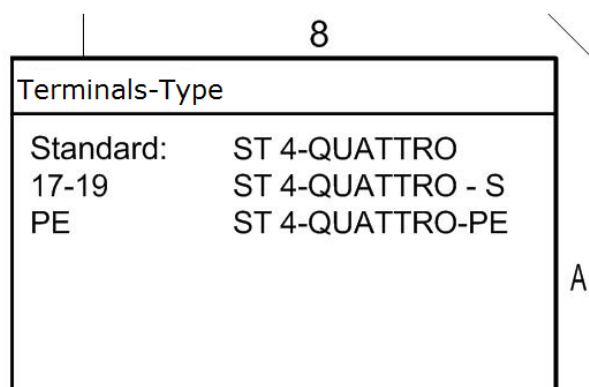

Example: filled table

Changing the display of the standard terminal type

Terminal Summary Options

- = **1**: The predefined standard terminal (attribute **Standard Terminal Type** at the terminal block) is used as the standard terminal type. If this attribute is not set, the terminal most used terminal is displayed as the standard terminal type.
- = **0**: The terminal most used is entered as standard terminal type.

5.4 Accessory in the Terminal Block Diagram

In the case of terminal accessories, you differentiate between accessories defined for terminal blocks (e.g. dividing plate, end clamp, end cover) and accessories defined for the terminal itself (testing socket, diode, shorting plug).

Accessories for the terminal block is usually entered at the block using the Terminal Block Designer, while it is displayed at the position of the attribute **TerminalSymbol**.

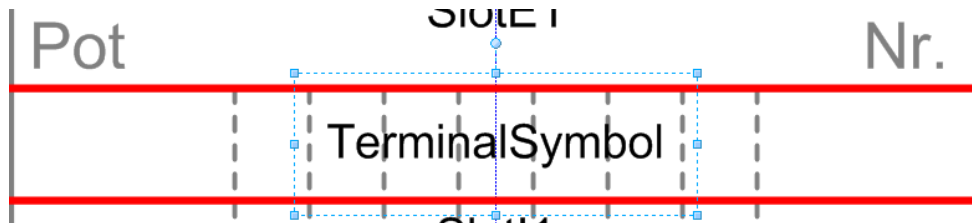

Position Attribute „TerminalSymbol“

Terminal accessories may be entered in different ways (Terminal Block Designer, Accessory Wizard). The representation or rather the position in the terminal block diagram depends on the entry into the respective accessory. For the object below the terminal two attributes are relevant.

You may enter a shape name into the attribute **Master-Shape for Terminal Block Diagram** (AID 10836) to then get it displayed in the terminal block diagram. The position derives from the content of the attribute **Position** (AID 261), for the terminal block diagram template are the positions of the attributes **SlotEn** and **SlotIn** essential.

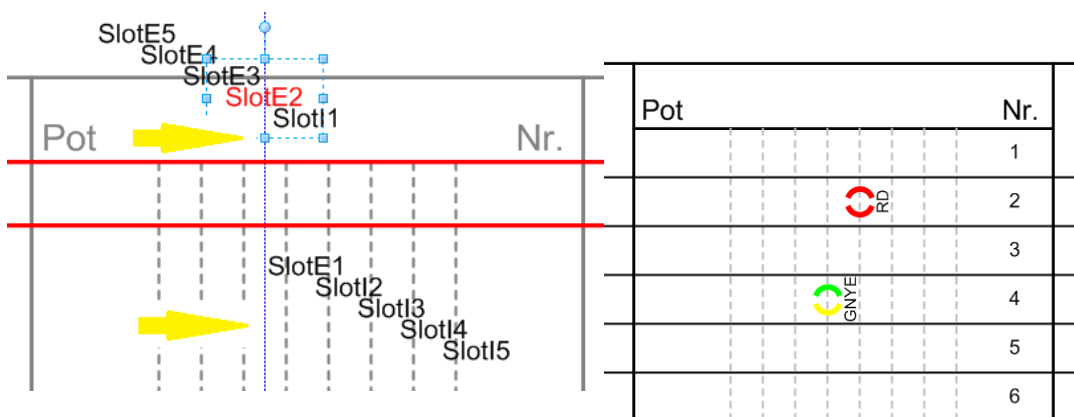

Entry in the template

Representation in the terminal block diagram

In the example above, five positions (slots) are defined each internally and externally corresponding with the contents of the attribute Position of the accessory below the terminal. If **Position** = -2, then the shape will be displayed at the position of the attribute **SlotE2**. If **Position** = -3, then the shape will appear at the position of the attribute **SlotE3**. Of course, the attributes **SlotEn** and **SlotIn** have to be placed within the red line having only been shifted for better clarity, here.

All shapes to be displayed in the terminal block diagram, have to be in the graphic toolbox on the stencils **Terminal accessories** and **Terminal accessories User**.

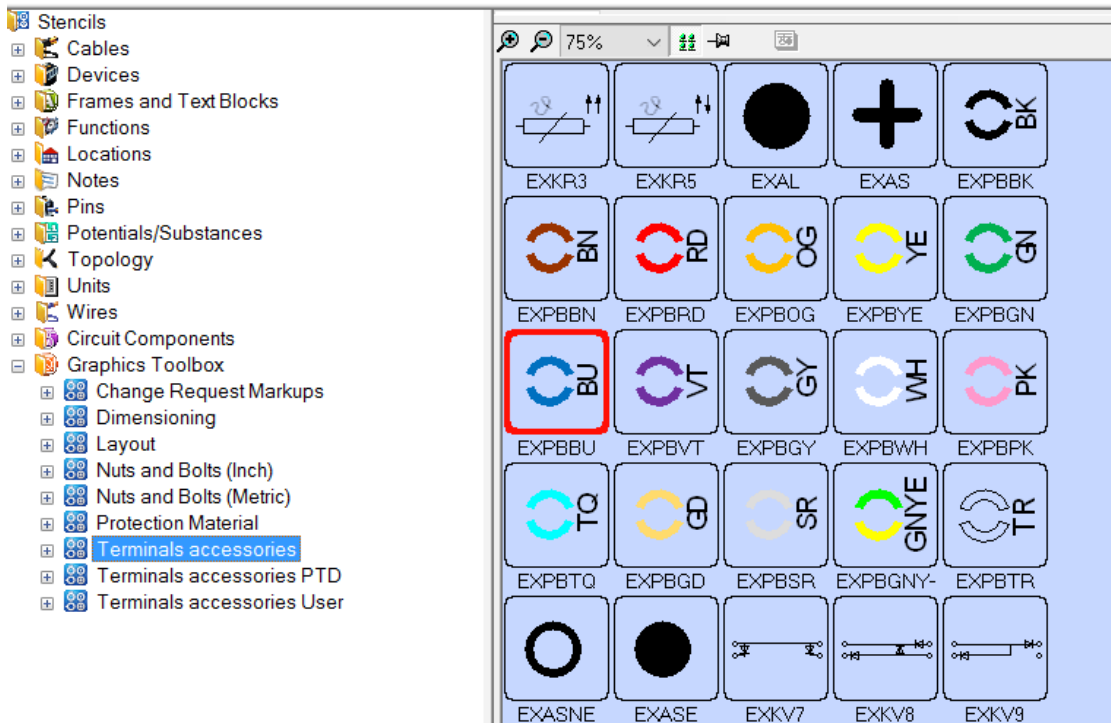

Stencil terminal accessories

5.5 Power PTD without Cable Matrix

A second alternative used in the power environment is the use of a terminal block diagram without cable matrix. The main difference is the way the cables and cores are represented, in this case line by line for the internal and the external sides.

There are two tables that represent the wire type and the terminal type. Due to the limited space only a few entries can be made here (see chapter 7.9, [Representation of Terminal Material in Several Columns](#)).

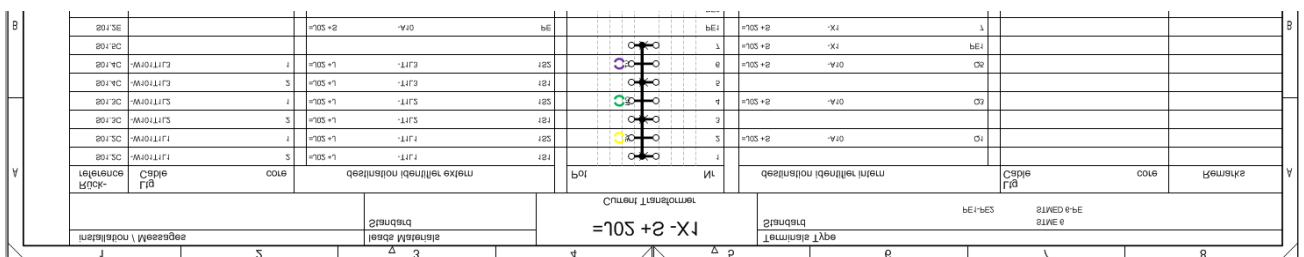

Example: terminal block diagram Power PTD without cable matrix

5.6 Multi-Column Terminal Block Diagram (VBSTB4)

For some terminal types it may be necessary to represent several destinations of a terminal in one line in adjacent columns. One example of this is the Phoenix VBSTB4 terminal type. From EB version 6.5.2, the terminal block diagram assistant can represent this kind of terminal block diagram; the graphic template is to be modeled accordingly.

The basis of the multi-column terminal block diagram is the terminal block connection diagram (15-matrix) of the PTD environment, here the cable, wiring and terminal information is already organized in tables. The number of cables is here limited to 9, with more than nine cables a new page is created.

The main point is that the setting must be made in the XML file; there the following lines are to be found and supplemented respectively.

```
<ExtDestinationsColumns Count="1" Width="-49"/>
<IntDestinationsColumns Count="3" Width="43"/>
```

Entries in the XML file for the multi-column terminal block diagram

In this case one column is shown to the left of the terminal (external) and three columns to the right of the terminal (internal). The column width is 49 mm for the external side and 43 mm for the internal side.

"-49" in the above example means that the additional columns are inserted to the left of the "external attributes" for destination and core/cable (if count > 0!).

"43" in the above example means that the additional columns are inserted to the right of the "internal attributes" for destination and core/cable (if count > 0!).

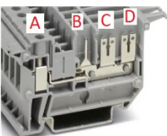
1		2		3		4		5		6		7		8					
No.	Cable	Bel. Adern: Blatt \ insg.	Cable-Type	Querschn.	core	-X_S				Leitungsmaterial	Diam.:	colour	Terminals-Type						
1	-W_S1	4	4	6	6					Standard:H07V-K	1.5mm²	sw	Standard: ST 4-QUATTRO						
2	-W_S2	1	1	6	6					1	H07V-K	2.5mm²	sw	Standard: ST 4-QUATTRO-PE					
Proc-be-core A <input type="checkbox"/> B <input type="checkbox"/> C <input type="checkbox"/> D <input type="checkbox"/>																			
Rück-reference	No.									destination identifier extern				destination identifier intern				reference	
G01.3B	1	2	3	4	5	6	7	8	9	1	-X5 AB		1L+	-F13 B		-F12 D	D	G01.4B, G01.4E	
G01.3C										3	-X5 2B		1L-	-F12 B		-F13 D		G01.4C, G01.4C	
G01.3D	1									2	-F10		10L+	-F10		4		G01.3E	
	2												10L-						
G01.4D	3									2	-F12		12L+					G01.4E	
	4												12L-	-F12		4		G01.4E	

Example: multi-column terminal block diagram

An important point is the representation of the cores and wires depending on their position at the terminal. This is made clear by the graphic and the specification **A**, **B**, **C** and **D** in the image of the terminal and the graphics above the individual cable entries.

One or two pieces of information per pin and connected core are entered in the corresponding line.

Pin cable-core				
A	B	C	D	
1	1	43	12	X
Core 1 is connected to pin A	Core 1 is connected to pin B	Core 4 is connected to pin B, core 3 to pin C	Core 1 is connected to pin C, core 2 to pin D	Core without name is connected to pin C

6 Tips and Tricks

6.1 Making a Copy

Before changing a terminal block diagram template you should always make a copy. For this purpose copy the respective template in the folder **Templates\Sheets\Favorites** and store it under another name.

6.2 Editing in the Full-Screen Mode

Once all graphic changes have been carried out, the terminal block diagram should be returned to the full-screen mode with **<CTRL+SHIFT+W>**; the completed terminal block diagram is then likewise started in the full-screen mode.

6.3 Save

In between individual changes, you should always store and check the intermediate result.

7 Settings in the XML File

Some of the control commands can be changed directly in the graphic template, and some can only be set via the configuration file. If the required value is not present in the file, then you can use an editor to insert it anywhere.

7.1 Formatting Attribute Texts

For attribute texts, you can change the font, the text size, the style and the alignment at the terminals. The standard font is Arial.

The general syntax for formatting text is:

<Attribute name in the terminal block diagram Formatting >x-Coordinate of the attribute in the terminal block diagram</Attribute name in the terminal block diagram>

Attribute name: see the red attribute names in the figure in chapter 8.1, [Overview of the Attributes and Parameters](#).

Formatting: possible formatting are Font, Style, Size, Color and Align (see the table in the following).

X coordinate: You can take the x coordinate for the terminal block diagram either from other control commands for this attribute, or you can determine it from the terminal block diagram template (mark the attribute, tab View/Task Pane/Size and Position).

To clarify the point, we present in the following a number of text formatting examples.

Output without formatting

Device	Pin
-C7	2
-F903	1

Output with formatting of the object device:

```
<IntItem Font="Tahoma" Size="2" Color="3">392</IntItem>
```

Device	Pin
-C7	2
-F903	1

Output with formatting of the objects device and pin:

```
<IntItem Font="Tahoma" Size="2" Color="3">392</IntItem>
```

```
<IntPin Font="Tahoma" Size="4" Color="4">406.5</IntPin>
```

Device	Pin
-C7	2
-F903	1

It is evident that the text size "Size" = 4 at the pin is too large in this example. Changing the value to 3 makes sense!

Output with formatting of the 5 objects device and pin:

```
<IntItem Font="Tahoma" Size="2" Style="BI" Color="3">392</IntItem>
```

```
<IntPin Font="Tahoma" Size="3" Style="U" Color="4">406.5</IntPin>
```

Device	Pin
-C7	<u>2</u>
-F903	<u>1</u>

For text formatting in the XML file, the following rules apply:

Name	Syntax	Possible values
Font	Font="Tahoma"	All fonts installed on this computer (the default is Arial).
Scale	Scale="m.nn"	Definition of scale as decimal number in the format m.nn . The text will be displayed narrower or wider, the text height corresponds to the font defined. 1.00: Scale 100% >1.00: The text will be displayed wider. For example, the value 1.20 corresponds to a scale of 120 %. <1.00: The text will be displayed narrower. For example, the value 0.90 corresponds to a scale of 90 %.
Size	Size="2.275"	Permitted are decimal numbers.

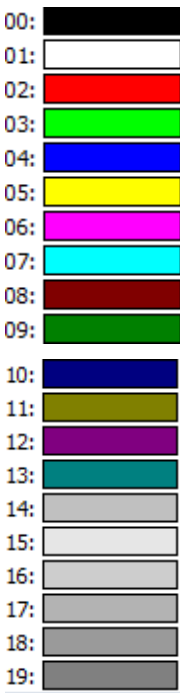
Style	Style="BI"	Here only the following capital letters are permitted: <ul style="list-style-type: none"> • B (Bold) • I (Italics) • U (Underline)
Align	Align="4"	Specification of the text alignment with values between 1 and 9 (the default is 5). <ul style="list-style-type: none"> 1- Top left 2 - Top center 3 - Top right 4 - Center left 5 - Center center 6 - Center right 7 - Bottom left 8 - Bottom center 9 - Bottom right
Color	Color="0"	Integers from the table. 

7.2 Cutting Rules for Destination Information

The cutting rule for destination information depends on the entry

- **<ShortDeviceName>1</ShortDeviceName>.**

If this cutting rule is to be switched off altogether, then this entry must be removed. The rule as such is not changed!

7.3 Separators in the Destination Designation

You can use the following commands to define separators between devices and pins or cables and cores. The prerequisite is that the names of the device and the pin are present in an attribute (AID).

- **<PinSeparator>**:**</PinSeparator>** separator ":" between device and pin
- **<CableCoreSeparator>**:**</CableCoreSeparator>** separator ":" between cable and wire.

7.4 Separators in the Target Pin Designation

Via the following command, you can define a separator that is inserted between the individual components of the target pin designation.

<TerminalSeparator>;**</TerminalSeparator>** Separator ";" between the components of the target pin designation:

- Terminal Segment Designation
- Terminal Number

7.5 Pin designation.No Cable Matrix

If the terminal block diagram is to be created without cable matrix, then the following setting must be made in the XML file:

<CablesInRow>1</CablesInRow>

If the terminal block diagram contains a cable matrix, then this entry must be removed!

7.6 Changing the Sorting of the Terminals in the Terminal Block Diagram

Change the value of the switch **<SortTerminalOptions>** depending on the desired sorting mode.

- **<SortTerminalOptions>0</SortTerminalOptions>** Sorting by the positions of the terminal segments and then by the terminal numbers (Default).
- **<SortTerminalOptions>1</SortTerminalOptions>** Sorting only by the terminal numbers.

7.7 Suppressing Blank Spaces when Displaying External and Internal Destinations

The attributes **FunctionSeparator** and **LocationSeparator** control the display of the blanks. In the standard configuration of the terminal block diagram template, these are not shown.

Insert the two commands

- **<FunctionSeparator>****</FunctionSeparator>**
- **<LocationSeparator>****</LocationSeparator>**

into the XML configuration of the terminal block diagram template.

If blanks are again to be used as separators, then you can achieve this either with the two commands shown in the following or via the graphic editor (see chapter 10.3, [Display](#)).

- **<FunctionSeparator>****<![CDATA[]></FunctionSeparator>**
- **<LocationSeparator>****<![CDATA[]></LocationSeparator>**

7.8 Jumper Representation without Endpoints

Fixed bridges not represented by a shape in the terminal block diagram are by default shown with end points.

Change the value of the switch **<BridgeOptions>** depending on the desired representation.

- **<BridgeOptions>0</BridgeOptions>** for a representation with end points (default).
- **<BridgeOptions>2</BridgeOptions>** for a representation without end points.

7.9 Representation of Terminal Material in Several Columns

The **Terminal Diagram without cable matrix EVU** offers in its header only space for three rows for the representation of the terminal material used. With the following changes you may define up to four columns with a maximum of 40 characters.

```
<TerminalSummary1 DeltaY="285" LastRow="277" LineSpace="4" LineFrom="244"
LineTo="244" Size="3" NumberOfColumns="4" ColumnWidth="40">
```

```
    <Index Size="2.625" Align="8">276</Index>
```

```
    <AttrID1>10347</AttrID1>
```

```
    <AttrPosition1 Size="2.625">280</AttrPosition1>
```

```
</TerminalSummary1>
```

NumberOfColumns indicates the number of columns in the area of the terminal material (Default = "1").

ColumnsWidth specifies the width of the columns (Default = "50").

7.10 Graphic Representation of Switches

In the Terminal Block Designer, you can define and graphically display disconnect switches. For this purpose the attribute **Is Disconnect Switch** must be marked. It depends on the attribute **Switch Default Closed** whether the disconnect switch is shown open or closed.

There are 2 ways to activate the graphic display of disconnect switches:

Change in the Configuration Editor of the terminal diagram template

It may be that with the standard configuration of your terminal diagram template the attribute **Switch** is not listed.

Insert the following command into the terminal diagram template.

- **<Switch>xxx</Switch>** ; **xxx** stands for the Y coordinate in the terminal diagram template.

Change in the graphic editor of the terminal diagram template

Drag the attribute **Switch** from the left margin to the respective place in the template where the information is to be displayed.

7.11 Representation of Master-Shapes in the Foreground

In the Terminal Block Connection Diagram, the attribute values are usually displayed in the foreground (**Shape Options = 0**). It is possible to display the master-shapes for terminal accessory (attribute **Master-Shape for Terminal Block Diagram**) in the foreground and to superimpose thereby the display of the attribute values.

Settings in the Configuration editor of the terminal block diagram template

Change the value of the switch **<ShapeOptions>** depending on the desired representation.

- **<ShapeOptions>0</ShapeOptions>** The attribute values are displayed in the foreground of the terminal row (default).
- **<ShapeOptions>1</ShapeOptions>** The master-shapes are displayed in the foreground of the terminal row.

Settings in the graphic editor of the terminal block diagram template

Assign the value **1** to the attribute **Shape Options**.

7.12 Display of the Cross-Reference for Unconnected Terminals

The cross-references of terminals which have been placed onto a circuit diagram but which are not connected are usually not displayed. Using the following parameters, you can have the cross-references displayed:

<TerminalRepresentationOptions>2</TerminalRepresentationOptions> If the parameter has the value "2", the cross-references are displayed.

For further application possibilities of the parameter, please refer to chapter 10.3, [Display](#).

7.13 XML Commands

<ShortDeviceName>1</ShortDeviceName>

Shortening rule for target information. If you want to switch off this shortening rule, then you have to remove this input.

- **<CablesInRow>1</CablesInRow>**

If you remove this input, then the cable matrix will not be displayed in the terminal block diagram.

- **<Switch>xxx</Switch>**

Representation of disconnect switches. Here, xxx stands for the Y coordinate in the terminal block diagram template.

8 Settings in the Graphic

8.1 Overview of the Attributes and Parameters in the Terminal block diagram Template

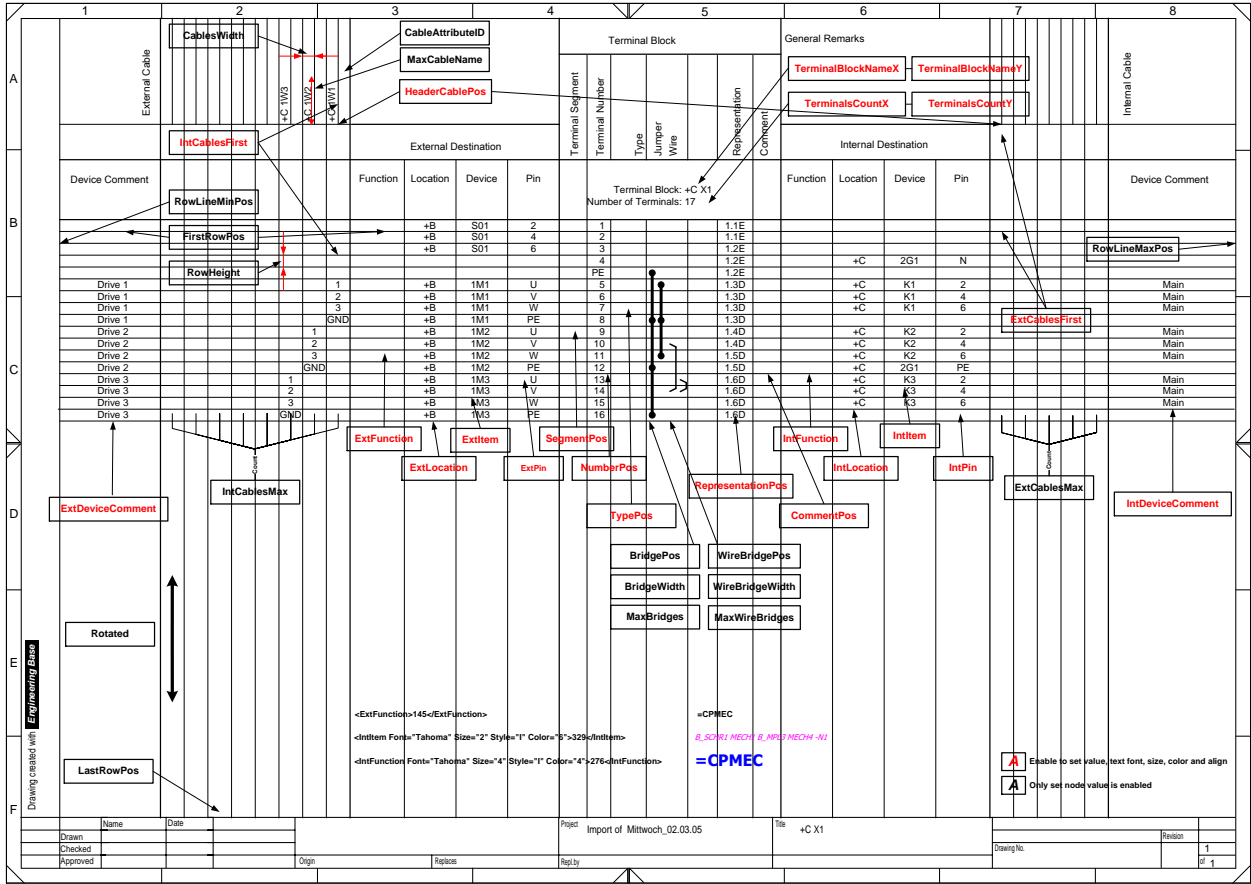

9 List of the Attributes

Attributes outside of the drawing area are not taken into account for the creation, i.e. if you do not want to show attributes, you must move them beyond the sheet margin.

If you delete attributes, then these are automatically re-created during a restart (outside of the drawing area). For all attributes created (outside of the drawing area), the count starts with the last valid value found.

When an attribute with the value=0 is found, then the following attributes are no more loaded (example TerminalAttr2=0 und TerminalAttr6=10060). Likewise these attributes are no longer taken into account for the display.

9.1 Terminal Blocks

Attribute name	Description (Representation in XML configuration file)
TerminalBlockName	Name of the terminal block. (<code><TerminalBlockNameX Size="4.7625" Align="5">247</TerminalBlockNameX></code> <code><TerminalBlockNameY>253</TerminalBlockNameY></code> Specifies the X and Y coordinates of the attribute. By defining the X coordinate, also the size and the font color are specified.)
Terminals Count	Number of terminals. (<code><TerminalsCountX>1</TerminalsCountX></code> <code><TerminalsCountY>192.38</TerminalsCountY></code> Specifies the X and Y coordinates of the position, where the attribute was placed in the terminal block diagram.)
Terminal Block Info=-1	Display of a single attribute of the terminal block, do not use
TBlockAttrn=nnnnn (TerminalBlockAttributes)	Display of any attribute of the terminal block; you can replace "nnnnn" with an attribute ID, e.g. TBlockAttr1=25. (Display of all defined attributes of the terminal block <code><TerminalBlockAttributes></code> <code><Attribute ID="25" Align="2">377</Attribute></code> <code><Attribute ID="11172" Size="1.875" Align="2" DeltaY="248">183</Attribute></code> <code></TerminalBlockAttributes></code>)

9.2 Segments

Attribute name	Description (Representation in XML configuration file)
Segm.	Name of the segment. (<code><SegmentPos>267.58229</SegmentPos></code>)
SegmentAttrn=nnnnn	Display of any attribute of the segment; you can replace "nnnnn" with an attribute ID., e.g. SegmentAttr1=25. (<code><SegmentAttributeID1>25</SegmentAttributeID1></code> <code><SegmentAttributePosition1>232</SegmentAttributePosition1></code>)

9.3 Terminals and Destinations

Attribute name	Description (Representation in XML configuration file)
1.CableE	Position of the first external cable; must always be present if cable/core information is to be shown in one line in the terminal block diagram (see chapter 5.3.1 The Cable Table). (<code><ExtCablesFirst>46</ExtCablesFirst></code>)
1.CableI	Position of the first internal cable; must always be present if cable/core information is to be shown in one row in the terminal block diagram (see chapter 5.3.1 The Cable Table). (<code><IntCablesFirst>54</IntCablesFirst></code>)
Comment	Comment for the terminal. (<code><CommentPos>125</CommentPos></code>)
DeviceCommentE	Comment for external device. (<code><ExtDeviceComment>44</ExtDeviceComment></code>)
DeviceCommentE	Comment for external device
DeviceCommentI	Comment for the internal device. (<code><IntDeviceComment>188</IntDeviceComment></code>)
ExtRepr. (external pin, left)	Creates for each external pin of the terminal a cross-reference. (<code><ExtRepresentation>40</ExtRepresentation></code>)
ExtCableCore	Cable and core of external target <CableCoreSeparator>:</CableCoreSeparator> defines the separator ":" between cable and core. (<code><ExtCableCore>154</ExtCableCore></code>)

ExtCableCoreAttrn=nnn	Display of an arbitrary attribute of the cable core at an external destination; "nnnnn" may be replaced by an attribute ID, e.g. ExtCableCoreAttr1=5 (<ExtCableCoreAttributeID1>5</ExtCableCoreAttributeID1> > <ExtCableCoreAttributePosition1>48</ExtCableCoreAttributePosition1>)
ExtCableCoreDestination	Device and pin of external target. <PinSeparator> : </PinSeparator> Defines the separator ":" between device and pin. (<ExtCableCoreDestination>148</ExtCableCoreDestination>)
ExtDestInfo	In the terminal diagram the value specified in the attribute Destination Pin Info is displayed. (<ExtDestPinInfo>152.23841</ExtDestPinInfo>)
ExtDevAttrn=nnnnn	Display of any attribute of the external device; you can replace "nnnnn" with an attribute ID., e.g. ExtDevAttr1=25. (<ExtDeviceAttributeID1>25</ExtDeviceAttributeID1> <ExtDeviceAttributePosition1>152</ExtDeviceAttributePosition1>)
ExtPinAttrn=nnnn	Display of an arbitrary attribute of the external pin; "nnnnn" may be replaced by an attribute ID, e.g. ExtPinAttr1=5. (<ExtPinAttributeID1>5</ExtPinAttributeID1> <ExtPinAttributePosition1>150</ExtPinAttributePosition1>)
ExtPotential	Display of the externally connected potential. (ExtNodePotentia>148</ExtNodePotential>)
ExtTerminalPin	Name of the terminal pin, the external device is connected to. (<ExtTerminalPin>152</ExtTerminalPin>)
ExtWireAttrn=nnnnn	Display of any attribute for the external wire; you can replace "nnnnn" with an attribute ID., e.g. ExtWireAttr1=25. See chapter 5.3.1, The Cable Table . (<ExtWireAttributeID1>25</ExtWireAttributeID1> <ExtWireAttributePosition1>47</ExtWireAttributePosition1>)
ExtWireDestination	Display of the destination of the external wire. (<ExtWireDestination>148</ExtWireDestination>)
ExtWireIndex	See chapter 5.3.1, The Cable Table . (ExtWireIndex Fond" „ DeltaY=" „ >cccc<ExtWireIndex>)
FunctionE	Function name of the external device. (<ExtFunction>87</ExtFunction>)

FunctionI	Function name of the internal device. (<code><IntFunction>126.597</IntFunction></code>)
GroupWiresAttrn=nnnn (up to now WiresAttrn=nnnnn)	Grouping of wires not assigned to a cable but to be shown in the cable table. You can replace nnnnn with any attribute-ID. (<code><GroupWiresAttributeID1>5</GroupWiresAttributeID1></code>)
IntCableCore	Cable and core of internal target <CableCoreSeparator>:</CableCoreSeparator> defines the separator ":" between cable and core. (<code><IntCableCore>154</IntCableCore></code>)
IntCableCoreAttrn=nnnn	Display of an arbitrary attribute of the cable core at an internal destination; "nnnnn" may be replaced by an attribute ID, e.g. IntCableCoreAttr1=5 (<code><IntCableCoreAttributeID1>5</IntCableCoreAttributeID1></code> > <ExtCableCoreAttributePosition1>156</ExtCable-CoreAttributePosition1>)
IntCableCoreDestination	Device and pin of internal target <PinSeparator>:</PinSeparator> defines the separator ":" between device and pin. (<code><IntCableCoreDestination>148</IntCableCoreDestination></code> >)
IntDestInfo	In the terminal diagram the value specified in the attribute Destination Pin Info is displayed. (<code><IntDestPinInfo>152</IntDestPinInfo></code>)
IntDevAttrn=nnnnn	Display of any attribute of the internal device; you can replace "nnnnn" with an attribute ID, e.g. IntDevAttr1=5. (<code><IntDeviceAttributeID1>5</IntDeviceAttributeID1></code> <IntDeviceAttributePosition1>147</IntDeviceAttributePosition1>)
IntPinAttrn=nnnn	Display of an arbitrary attribute of the internal pin; "nnnnn" may be replaced by an attribute ID, e.g. IntPinAttr1=5. (<code><IntPinAttributeID1>5</IntPinAttributeID1></code> <IntPinAttributePosition1>150</IntPinAttributePosition1>)
IntPotential	Display of the internally connected potential. (<code>IntNodePotential>148</IntNodePotential></code>)
IntRepr.(internal pin, right)	Creates for each external pin of a terminal a cross-reference. (<code><IntRepresentation>405</IntRepresentation></code>)
IntTerminalPin	Name of the terminal pin, the internal device is connected to. (<code><IntTerminalPin>460</IntTerminalPin></code>)

IntWireAttrn=nnnnn	Display of any attribute for the internal wire; you can replace "nnnnn" with an attribute ID., e.g. IntWireAttr1=5. See chapter 5.3.1 The Cable Table . (<code><IntWireAttributeID1>5</IntWireAttributeID1></code> <code><IntWireAttributePosition1>318</IntWireAttributePosition1></code>)
IntWireDestination	Display of the destination of the internal wire. (<code><IntWireDestination DeltaY="-54.81">148</IntWireDestination></code>)
IntWireIndex	See chapter 5.3.1, The Cable Table . (<code>IntWireIndex Fond" ,, DeltaY=" ,, >cccc<IntWireIndex></code>)
ItemE	External device (<code><ExtItem Align="2">162</ExtItem></code>)
ItemI	Internal device. (<code><IntItem Align="2">312</IntItem></code>)
LocationE	Unit name of the external device. (<code><ExtLocation Align="8">155</ExtLocation></code>)
LocationI	Unit name of the internal device. (<code><IntLocation Align="8">305</IntLocation></code>)
Num.	Terminal number (<code><NumberPos DeltaY="-8.81">270</NumberPos></code>)
PartOfE	Part of the external device. (<code><ExtPartOf DeltaY="-52.81">153.78235</ExtPartOf></code>)
PartOfI	Part of the internal device. (<code><IntPartOf DeltaY="-52.81">153.78235</IntPartOf></code>)
PinE	Name of the pin for the external device. (<code><ExtPin DeltaY="8">208</ExtPin></code>)
PinI	Name of the pin for the external device. (<code><IntPin DeltaY="8">358</IntPin></code>)
Potential	Name of the potential connected to the terminal. (<code><NodePotential>140.63744</NodePotential></code>)
Repr.	Representation of the terminal in the circuit diagram. (<code><RepresentationPos>140</RepresentationPos></code>)
SlotEn	SlotE designates the external position of an accessory shape for the terminal; "n" can be a value between 1 and 8. (<code><SlotE1>248</SlotE1></code>)
SlotIn	SlotI designates the internal position of an accessory shape for the terminal; "n" can be a value between 1 and 8. (<code><SlotI1>248</SlotI1></code>)

Switch	Position for representing the switch for a disconnect terminal. (<code><Switch>248</Switch></code>)
TerminalAttrn=nnnn (TerminalAttributes)	Display of an arbitrary attribute of the terminal; you may replace "nnnnn" by an attribute ID, e.g. TerminalAttr1=25. (Display of all defined attributes of the terminal <code><TerminalAttributes></code> <code><Attribute ID="10" Align="2">377</Attribute></code> <code><Attribute ID="5" Align="2">377<Attributes></code> <code><TerminalAttributes></code>)
TerminalSymbol	X coordinate of the shape for terminal line, end plates and end holders. (<code><TerminalSymbol>264</TerminalSymbol></code>)
type	Terminal type (<code><TypePos>142</TypePos></code>)

9.4 Cables

Attribute name	Description (Representation in XML configuration file)
CableAttrn=nnnnn	Display of any attribute of the cable; you can replace "nnnnn" with an attribute ID (to be used only in connection with the red frame "CableWidth") (e.g. CableAttr1=25). (<code><CableAttributeID1>25</CableAttributeID1></code>)
ExtCableAttrn=nnnnn	Display of any attribute of the external cable; you can replace "nnnnn" with an attribute ID, e.g. ExtCableAttr1=5. (<code><ExtCableAttributeID1>25</ExtCableAttributeID1></code> <code><ExtCableAttributePosition1</code> <code>Align="2">40</ExtCableAttributePosition1></code>)
ExtCableSumRef	Position of the reference numbers of the external cables in the cable table. (<code><ExtCableSummaryReference>51</ExtCableSummaryReference></code>)
GroupCablesAttrn=nnnn	If defined, multiple cables with equal attributes may reside in one column of the cable matrix. Display of an arbitrary attribute of a cable group; "nnnnn" may be replaced by an attribute ID, e.g. IntCableAttr1=5. (<code><GroupCablesAttributeID1>5</GroupCablesAttributeID1></code>)
HeaderCablePos	Position of the cable name (to be used only in connection with the red frame "CableWidth"). (<code><HeaderCablePos>56.</HeaderCablePos></code>)
IntCableAttrn=nnnnn	Display of an arbitrary attribute of the internal cable; "nnnnn" may be replaced by an attribute ID, e.g. IntCableAttr1=5. (<code><IntCableAttributeID1>5</IntCableAttributeID1></code> <code><IntCableAttributePosition1>127</IntCableAttributePosition1></code>)
IntCableSumRef	Position of the reference numbers of the internal cables in the cable table. (<code><IntCableSummaryReference>51</IntCableSummaryReference></code>)

9.5 Tables

Attribute name	Description (Representation in XML configuration file)
CSummaryAttrn=nnnnn	Display of any attribute of the cable; you can replace "nnnnn" with an attribute ID, e.g. CSummaryAttr1=5. (<code><CableSummary DeltaY="283" LastRow="233" LineSpace="4" LineFrom="20" LineTo="20" Size="3"> <AttrID1>5</AttrID1><AttrPosition1>34</AttrPosition1> </CableSummary></code>)
CSummaryIndex	Index (consecutive numbering) of the cables in the table (start at 1). See chapter 5.3.1 The Cable Table . (<code><CableSummary ... <Index Align="8">30</Index</CableSummary></code>)
CsummarySheetWire-Count	Displays the number of assigned cores on sheet. (<code><CableSummary ... <SheetWireCount Align="8">94</SheetWireCount></CableSummary></code>)
CsummereryUsedWire-Count	Displays the number of assigned cores in the cable. (<code><CableSummary ... <UsedWireCount Align="8">82</UsedWireCount></CableSummary></code>)
TSummaryAttrN=nnnnn	Display of any attribute of the terminal; you can replace "nnnnn" with an attribute ID, e.g. TSummaryAttr1=10347. (<code><TerminalSummary1 DeltaY="282" LastRow="233" LineSpace="4" LineFrom="356" LineTo="356" Size="3"> <AttrID1>10347</AttrID1> <AttrPosition1 DeltaY="-4">380</AttrPosition1></TerminalSummary1></code>)
TSummaryIndex	Index (consecutive numbering) of the terminals in the table (start at 1). (<code><TerminalSummary1... <Index DeltaY="-4">358</Index></TerminalSummary1></code>)
WSummaryAttrn=nnnnn	Display of any attribute for the wire; you can replace "nnnnn" with an attribute ID, e.g. WSummaryAttr1=10206. (<code><WireSummary DeltaY="282" LastRow="233" LineSpace="4" LineFrom="284" LineTo="284" Size="3"> <AttrID1>10206</AttrID1> <AttrPosition1>321</AttrPosition1></WireSummary></code>)
WSummaryIndex	Index (consecutive numbering) of the wires in the table (start at 1). (<code><WireSummary... <Index>288</Index></WireSummary></code>)

10 List of Parameters

You can use parameters to set various values. These can influence the output of the terminal block diagram or the behavior of the assistant. Only those parameters can be changed that have a "=" character following their names (see item 4.4, [Parameter](#)).

10.1 Bridges

Parameter name	Description (Representation in XML configuration file)
Bridge for Potential=0	<p>1: bridges are created if terminals have the same potential even if they are not connected by a wire.</p> <p>2: bridges are created if terminals have the same name even if they are not connected by a wire.</p> <p>(<code><ConnectPotentialByBridge>1</ConnectPotentialByB ridge></code>)</p>
Bridge Options=0	<p>0: Representation of the bridges with endpoints (<code><BridgeOptions>0</BridgeOptions></code>)</p> <p>1: no bridges are created for Automatic Wires.</p> <p>2: Representation of the fixed bridges without endpoints.</p> <p>See chapter 7.8 Jumper Representation without Endpoints.</p> <p>(<code><BridgeOptions>2</BridgeOptions></code>)</p>
MaxBridges=	<p>Maximum number of bridges that can be shown in the terminal block diagram.</p> <p>(<code><MaxBridges>2</MaxBridges></code>)</p>
MaxWireBridges=	<p>Maximum number of internal wire bridges that can be shown in the terminal block diagram.</p> <p>(<code><MaxWireBridges>2</MaxWireBridges></code>)</p>
MaxWireBridgesExt=	<p>Maximum number of external wire bridges.</p> <p>(<code><MaxWireBridgesExt>2</MaxWireBridgesExt></code>)</p>

10.2 Cables

Parameter name	Description (Representation in XML configuration file)
ExCableMax=	Maximum number of external cables; if the number is exceeded, there is a page break. (<code><ExtCablesMax>15</ExtCablesMax></code>)
IntCableMax=	Maximum number of internal cables; if the number is exceeded, there is a page break. (<code><IntCablesMax>1</IntCablesMax></code>)
MaxCableName=	Maximum length of the cable name. If the name is longer, then the output takes place in the next line. (<code><MaxCableName>15</MaxCableName></code>)

10.3 Display

Parameter name	Description (Representation in XML configuration file)
Parameter name	Description (Representation in XML configuration file)
CableCoreSeparator=	Defines the separator between cable and core, e.g. CableCoreSeparator=: for the separator ":". (<code><CableCoreSeparator> : </CableCoreSeparator></code>)
Data Option Mode =	Manages the representation 11 : current standard settings 15 : Displays all representations of terminals (in circuit diagrams). (<code><GetDataOPMode>11</GetDataOPMode></code>)
Function separator=	A separator separating the individual levels of the destination designations of the functions, the default is Blank . See chapter 7.7 Suppressing Blank Spaces when Displaying External and Internal Destinations . (<code><FunctionSeparator></FunctionSeparator></code> : suppression of blanks <code><FunctionSeparator><![CDATA[]]></FunctionSeparator></code> : blanks as separators)

HideTerminalBlockLocation=0	<p>0: Shows the terminal block name and all named units in the destination designations.</p> <p>1: With equal unit in the target designation and in the terminal block, the name of the unit will not be displayed.</p> <p>2: Stands for cutting rules according to DIN.</p> <p>(<HideTerminalBlockLocation>2</HideTerminalBlockLocation>)</p>
Location separator=	<p>A separator separating the individual levels of the destination designations of the units, the default is Blank. See chapter 7.7 Suppressing Blank Spaces when Displaying External and Internal Destinations.</p> <p>(<LocationSeparator></LocationSeparator>: Suppression of blanks <LocationSeparator><![CDATA[]]></LocationSeparator>: blanks as separators)</p>
New Column For Sub-Cables=	<p>Blank: Only for the most frequent cables a separate column will be created.</p> <p>1: Separate columns are created for cables that themselves are parts of a cable.</p> <p>2: Cables of type = Pair will be displayed in one column.</p> <p>(<NewColumnForSubCables>1<NewColumnForSubCables>)</p>
Pin Separator=	<p>Defines the separator between device and pin, e.g. Pin Separator=: for the separator ":".</p> <p>(<PinSeparator>:</PinSeparator>)</p>
Shape Options=	<p>0: In the terminal row, the attribute values will be displayed in the foreground (Default).</p> <p>(<ShapeOptions>0</ShapeOptions>)</p> <p>1: In the terminal row, the Master Shapes will be displayed in the foreground.</p> <p>(<ShapeOptions>1</ShapeOptions>)</p>
Terminal Representation Options=	<p>0: Internal and external representations will be displayed.</p> <p>1: Only the representation within the drawing is shown.</p> <p>2: The cross-reference of a terminal that is placed on the circuit diagram but not connected is displayed.</p> <p>(<TerminalRepresentationOptions>1</TerminalRepresentationOptions>)</p>

Terminal Separator=	<p>Defines a separator to make the target pin designation easier to read.</p> <p>The separator is inserted between:</p> <ul style="list-style-type: none"> • Terminal Segment Designation • Terminal Number • Pin designation. <p><TerminalSeparator>;</TerminalSeparator></p>
Terminal Summary Options=	<p>0: The terminal most used is entered as standard terminal type.</p> <p>1: The predefined standard terminal (attribute Standard Terminal Type at the terminal block) is used as the standard terminal type. If this attribute is not set, the terminal most used terminal is displayed as the standard terminal type.</p> <p>(<TerminalSummaryOptions>1</TerminalSummaryOptions>)</p>

10.4 Control

Parameter name	Description (Representation in the XML configuration file)
Boolean Value False=False	<p>Specification of a value ("False") that is to be shown when no tick is placed.</p> <p>(<BooleanValueFalse>False</BooleanValueFalse>)</p>
Boolean Value True=True	<p>Specification of a value ("True") that is to be shown when a tick is placed.</p> <p>(<BooleanValueTrue>True</BooleanValueTrue>)</p>
Sort Terminal Options=	<p>0: Sorting is executed by the position of the terminal segments and then by the terminal number</p> <p>1: Sorting is executed only by the terminal number.</p> <p>(<SortTerminalOptions>0</SortTerminalOptions>)</p>

11 Red Frames

Parameter name	Description (Representation in XML configuration file)
CableWidth	Defines the column width in the cable table. (<code><CablesWidth>-4</CablesWidth></code>)
CSummaryLastLine	Marks the end of a range of rows. Manages the page break (see chapter 4.3 Red Frames). (<code><CableSummary .. LineTo="91"..</CableSummary></code>)
CSummaryLine	Marks the beginning of a range of rows. (<code><CableSummary .. LineFrom="19"..</CableSummary></code>)
First Row	Marks the beginning of a range of rows. (<code><FirstRowPos>219</FirstRowPos></code>)
Last Row	Marks the end of a range of rows (see chapter 4.3 Red Frames). (<code><LastRowPos>31</LastRowPos></code>)
TSummaryLastLine	Marks the end of the table of terminal types (see chapter 5.3.3 The Terminal Types). If this marker is reached, a page break occurs. (<code><TerminalSummary1 .. LineTo="91"..</TerminalSummary1></code>)
TSummaryLine	Marks the beginning of the table of terminal types (see chapter 5.3.3 The Terminal Types). (<code><TerminalSummary1 .. LineFrom="19"..</TerminalSummary1></code>)
WSummaryLastLine	Marks the end of the table of conductor materials. (see chapter 5.3.2 The Wiring Material). If this marker is reached, a page break occurs. (<code><WireSummary .. LineTo="19"..</WireSummary></code>)
WSummaryLine	Marks the beginning of the table of conductor materials. (see chapter 5.3.2 The Wiring Material) (<code><WireSummary .. LineFrom="19"..</WireSummary></code>)

12 XML Commands Defining the Layout of the Terminal Block Diagram

<BridgePos>244</BridgePos>	X coordinate for the display of bridges.
<BridgeWidth>4</BridgeWidth>	Defines the width of the displayed bridges.
<WireBridgePos>274</WireBridgePos>	X coordinate for the display of internal wire jumpers (grafical representation Int1, Int2).
<WireBridgeExtPos>222</WireBridgeExtPos>	X coordinate for the display of external wire jumpers (grafical representation Ext1, Ext2).
< WireBridgeWidth >4</ WireBridgeWidth >	Defines the width of the displayed wire jumpers.
<RowLineMinPos>44</RowLineMinPos>	X coordinate for the left margin of the first column.
<RowLineMaxPos>380</RowLineMaxPos>	X coordinate for the right margin of the last column.
<RowLine Weight="0.25" Style="1"/>	Defines the width of the column margins.
<RowLineSegment Weight="0.15" Style="10"/>	Defines the kind of column margins of the segments.
<RowLineDestination Weight="0.15" Style="10"/>	Defines the kind of column margins of the destinations.
<RowHeight>6</RowHeight>	Defines the height of the rows.

No longer used, replaced XML commands

<RowFontSize>1.88</RowFontSize>	Standard font size for elements in a row. The font size may now be definded for nay element of the row.
<TerminalBlockInfoY> <TerminalBlockInfoAttributeID>	Replaced by TerminalBlockAttributes
<TypeAttributeID>	Replaced by TerminalAttributes